



New SuperLine II

Product Catalog

Dentium

Contents

New SuperLine II	Characteristics	06
	Color Coding by Diameter	07
	Fixture	08
Surgical Components	Cover Screw	09
	GBR Healing Abutment	09
	Healing Abutment	10
	Scan Abutment	12
Prosthetic Procedure 1	Dual / Combi Abutment - Abutment Level Impression	13
	Combi Abutment	14
	Dual Abutment	15
	Abutment Level Impression Components	17
	Restorative Kit	18
Prosthetic Procedure 2	Dual / Custom / Milling / Angled / Direct-Casting / Metal-Casting / Temporary (Plastic & Ti) Abutment - Fixture Level Impression	19
	Fixture Level Impression Components	20
	Milling Abutment	22
	Angled Abutment	24
	Direct-Casting Abutment	26
	Metal-Casting Abutment	26
	Ti-Temporary Abutment	27
	Plastic Temporary Abutment	27
	Prosthetic Procedure 3	Screw Abutment - Abutment Level Impression
Screw Abutment		29
Angled Screw Abutment		30
Screw Abutment Impression Components		31
Prosthetic Procedure 4	Overdenture Procedure - Positioner / Mini Ball / Magnetic Attachment	34
	Positioner	35
	Mini Ball Attachment	37
	Magnetic Attachment	38

Instruments

Surgical Kit (Full)	40
Surgical Kit (Stopper Drill Full)	41
Surgical Kit (Standard)	42
Surgical Kit (Short Implant)	43
Surgical Kit (Stopper Drill Kit)	44
Surgical Kit (Drill Stopper Kit)	45
Surgical Instrument	46
Osteotome Kit	55
Trephine Kit	56
Instrument	57
Screws& Pins	58
Prosthetic Kit	59
Planning Kit	60
Prosthetic and Laboratory Instrument	61
Help Kit	62
Polymer Guide Kit	63
DASK	64
Sinus Bur Kit	65
DASK / Sinus Bur Kit	66
Ridge Spreader Kit	67
Sinus Kit	68
Ridge Expander Kit	69
Implant Guide Kit	70
Digital Guide I Simple Kit I Positioning, Anchor	71
Digital Guide I Full Kit I FX 36/40/45	72
Digital Guide I 5.0 Kit I FX 36/40/45/50	73



S.L.A. Surface

S.L.A. (Sandblasting with Large grits and Acid etching)

- Higher bone-to-implant contact
- Faster bone formation on the surface

reference: Kim H., et. al. "The Biocompatibility of SLA-treated Titanium Implants" Biomed. Mater. 2008; 3(2):025011

In vivo test



SuperLine

New SuperLine II Characteristics

Joint stability & Improved strength for zirconia crown

- Abutment material: Grade 4 ➔ Ti-6Al-4V ELI

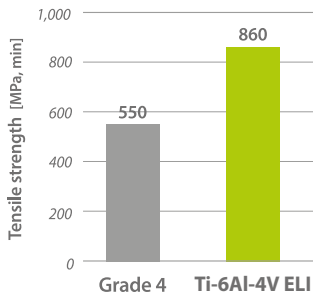

- Long hex design: Improved recognition

Improved soft tissue management

- Concave abutment design

Improved wall thickness

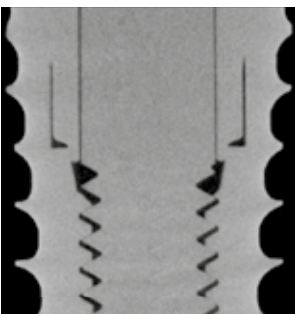

Double thread & Tapered design

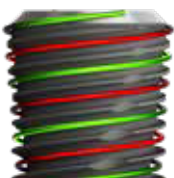

Double threaded tapered body design may provide better success rate in immediate loading cases.









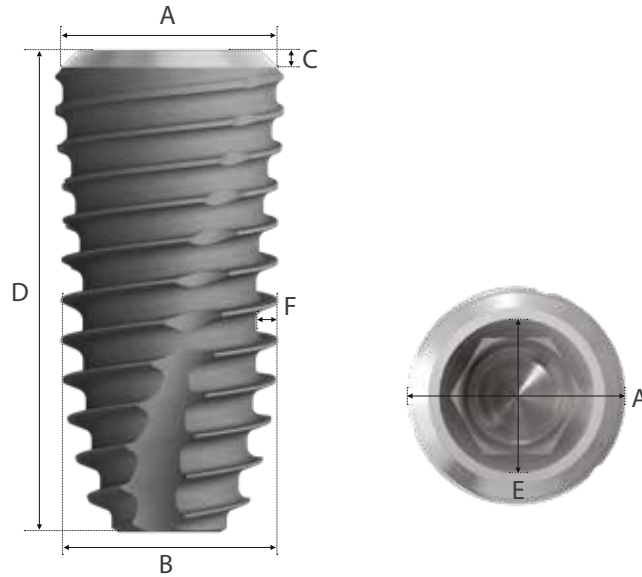



reference: Kim et. al., "A Prospective, 1-year observational study of double-threaded tapered body dental implants with immediate loading" J Prosthet Dent 2015;114:46-51

Height and sharper thread design



New SuperLine II Fixture Specifications



Fixture (Mount Free)								
A	Platform Diameter(Ø)	3.6	4.0	4.5	5.0	6.0	7.0	
B	Body Diameter(Ø)	3.6	4.0	4.5	5.0	5.0	5.8	
C	Bevel Height (mm)	L: 7	1.5	1.5	1.5	1.5	1.5	1.5
		L: 8, 10, 12, 14	0.03	0.20	0.35	0.60	0.70	1.00
D	Total Length(mm)	7, 8, 10, 12, 14						
E	Abutment Interface(Ø)	3.33	3.33	3.33	3.33	3.33	3.33	
F	Thread Depth(mm)	0.38	0.40	0.45	0.50	0.50	0.50	
Cap Color								
		Yellow	Green	Blue	Red	Orange	Violet	
Selection Guideline		Anterior	Anterior	Premolar	Molar	Molar	Molar	

New SuperLine II Fixture

Unit: mm, Scale 1.5 : 1

· Cover screw is not included in the package

Platform	Body	L	Art. No.
Ø 3.7	Ø 3.6	7	FXS 36 07
		8	FXS 36 08
		10	FXS 36 10
		12	FXS 36 12
		14	FXS 36 14

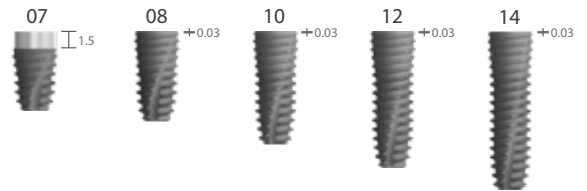

Ø 4.0	Ø 4.0	7	FXS 40 07
		8	FXS 40 08
		10	FXS 40 10
		12	FXS 40 12
		14	FXS 40 14

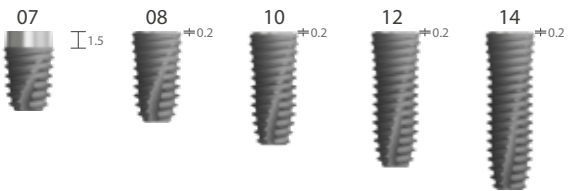

Ø 4.5	Ø 4.5	7	FXS 45 07
		8	FXS 45 08
		10	FXS 45 10
		12	FXS 45 12
		14	FXS 45 14

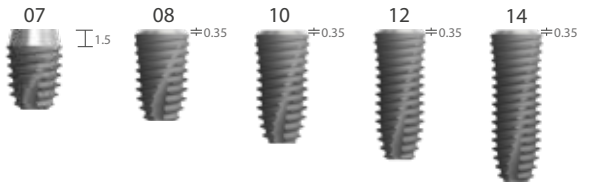

Ø 5.0	Ø 5.0	7	FXS 50 07
		8	FXS 50 08
		10	FXS 50 10
		12	FXS 50 12
		14	FXS 50 14

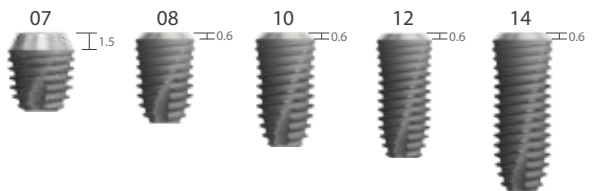

Ø 6.0	Ø 5.0	7	FXS 60 07
		8	FXS 60 08
		10	FXS 60 10
		12	FXS 60 12
		14	FXS 60 14

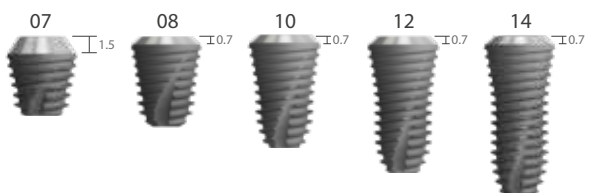

Ø 7.0	Ø 5.8	7	FXS 70 07
		8	FXS 70 08
		10	FXS 70 10
		12	FXS 70 12
		14	FXS 70 14

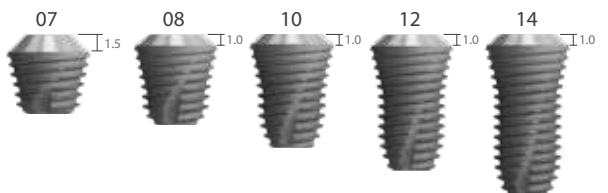

※ Note: To prevent damage to the Implant driver or fixture, do not over torque during fixture insertion.

Cover Screw

Unit: mm, Scale 1.5 : 1

• Single use only



Color	Diameter	Art. No.
Green	Ø 3.6	CS 36

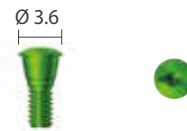

※ Hex driver: Use no more than 5N-cm of torque when screwing Cover Screw to a fixture.
If hex is worn, slot on the head of the product can be used to rotate it.

GBR Healing Abutment

Unit: mm, Scale 1.5 : 1



Diameter	G/H	Art. No.
Ø 3.3	3.5	GBHAB 33 35
Ø 3.8	0.5	GBHAB 38 05
Ø 3.8	2.0	GBHAB 38 20



※ Hex driver: Use no more than 10N-cm of torque when screwing GBR Healing Abutment to a fixture.
If hex is worn, slot on the head of the product can be used to rotate it.

Healing Abutment

Unit: mm, Scale 1.5 : 1

• Single use only



Diameter	G/H	H	Art. No.
\varnothing 4.0	2.0	2.0	HAB 40 20 20 E
	2.0	3.5	HAB 40 20 35 E
	3.0	5.0	HAB 40 30 50 E
	4.0	7.0	HAB 40 40 70 E
\varnothing 4.5	2.0	2.0	HAB 45 20 20 E
	2.0	3.5	HAB 45 20 35 E
	3.0	5.0	HAB 45 30 50 E
	4.0	7.0	HAB 45 40 70 E
\varnothing 5.5	2.0	2.0	HAB 55 20 20 E
	2.0	3.5	HAB 55 20 35 E
	3.0	5.0	HAB 55 30 50 E
	4.0	7.0	HAB 55 40 70 E
\varnothing 6.5	2.0	2.0	HAB 65 20 20 E
	2.0	3.5	HAB 65 20 35 E
	3.0	5.0	HAB 65 30 50 E
	4.0	7.0	HAB 65 40 70 E

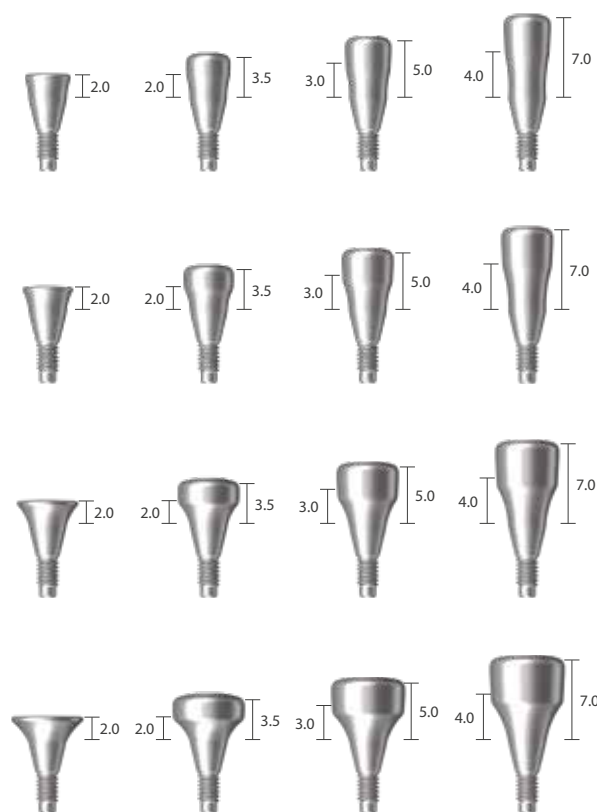

※ Hex driver: Use no more than 10N-cm of torque when screwing Healing Abutment to a fixture.
 If hex is worn, slot on the head of the product can be used to rotate it.

Healing Abutment

Unit: mm, Scale 1.5 : 1

Diameter	G/H	H	Art. No.
Ø 7.5	2.0	3.5	HAB 75 20 35 E
	3.0	5.0	HAB 75 30 50 E

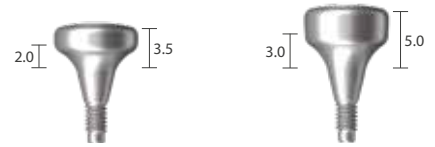

Ø 8.5	2.0	3.5	HAB 85 20 35 E
	3.0	5.0	HAB 85 30 50 E

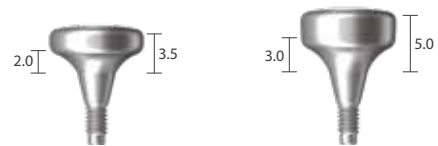

Ø 9.5	2.0	3.5	HAB 95 20 35 E
	3.0	5.0	HAB 95 30 50 E

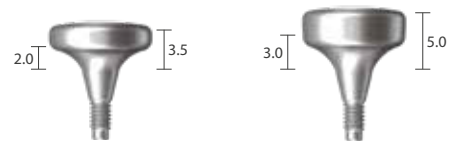

※ Hex driver: Use no more than 10N-cm of torque when screwing Healing Abutment to a fixture.
If hex is worn, slot on the head of the product can be used to rotate it.

Scan Abutment

Unit: mm, Scale 1.5 : 1

• Single use only

Diameter	G/H	H	Type	Art. No.
Ø 4.0	2.5	6.0	Hex	IHAB 40 06 H
	2.5	6.0	Non-hex	IHAB 40 06 N
	3.0	8.0	Hex	IHAB 40 08 H
	3.0	8.0	Non-hex	IHAB 40 08 N
	3.5	10.0	Hex	IHAB 40 10 H
	3.5	10.0	Non-hex	IHAB 40 10 N

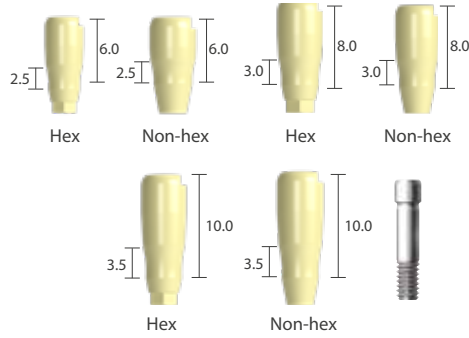

Diameter	G/H	H	Type	Art. No.
Ø 5.0	2.5	6.0	Hex	IHAB 50 06 H
	2.5	6.0	Non-hex	IHAB 50 06 N
	3.0	8.0	Hex	IHAB 50 08 H
	3.0	8.0	Non-hex	IHAB 50 08 N
	3.5	10.0	Hex	IHAB 50 10 H
	3.5	10.0	Non-hex	IHAB 50 10 N

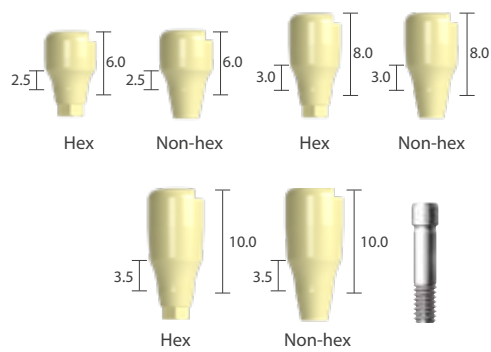

Diameter	G/H	H	Type	Art. No.
Ø 6.0	2.5	6.0	Hex	IHAB 60 06 H
	2.5	6.0	Non-hex	IHAB 60 06 N
	3.0	8.0	Hex	IHAB 60 08 H
	3.0	8.0	Non-hex	IHAB 60 08 N
	3.5	10.0	Hex	IHAB 60 10 H
	3.5	10.0	Non-hex	IHAB 60 10 N

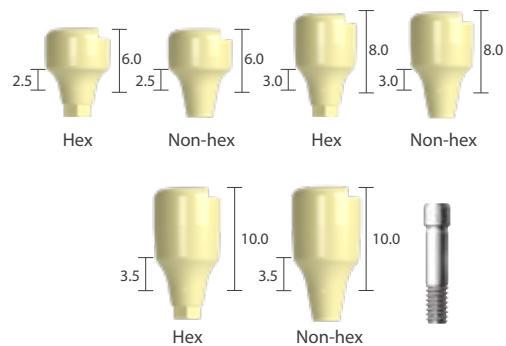

※ Hex driver: Use no more than 10N-cm of torque when screwing Scan Abutment to a fixture.
If hex is worn, slot on the head of the product can be used to rotate it.

Prosthetic Procedure 1

Impression Technique and Restoration Selection

Dual / Combi Abutment

Abutment Level Impression

Closed Tray Technique

Page 14

Combi Abutment

Ø 4.5 / Ø 5.5 / Ø 6.5



Page 15,16

Dual Abutment

Hex / Non-hex
Ø 4.5 / Ø 5.5 / Ø 6.5



Page 17

Impression Coping

Transfer (Snap on)
Ø 4.5 / Ø 5.5 / Ø 6.5



Page 17

Analog

Short
Ø 4.5 / Ø 5.5 / Ø 6.5



Page 17

Analog

Long
Ø 4.5 / Ø 5.5 / Ø 6.5



Burn-out Cylinder

Page 17

Bridge

Rotational
Ø 4.5 / Ø 5.5 / Ø 6.5



Page 17

Single

Non-rotational
Ø 4.5 / Ø 5.5 / Ø 6.5



Modification

Cemented Restoration

Combi Abutment

Unit: mm, Scale 1 : 1

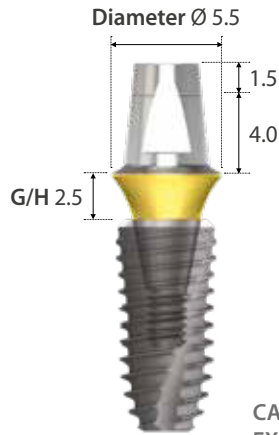

CAB5525
FXS4510

Diameter	G/H	Type	Art. No.	Type	Art. No.
Ø 4.5	1.0	Short	CAB 45 10 S	Long	CAB 45 10
	1.5		CAB 45 15 S		CAB 45 15
	2.5		CAB 45 25 S		CAB 45 25
	3.5		CAB 45 35 S		CAB 45 35
	4.5		CAB 45 45 S		CAB 45 45
	5.5		CAB 45 55 S		CAB 45 55

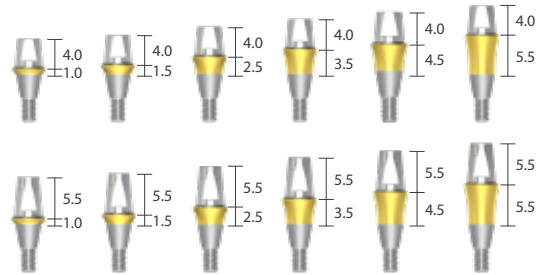

Ø 5.5	1.5	Short	CAB 55 15 S	Long	CAB 55 15
	2.5		CAB 55 25 S		CAB 55 25
	3.5		CAB 55 35 S		CAB 55 35
	4.5		CAB 55 45 S		CAB 55 45
	5.5		CAB 55 55 S		CAB 55 55

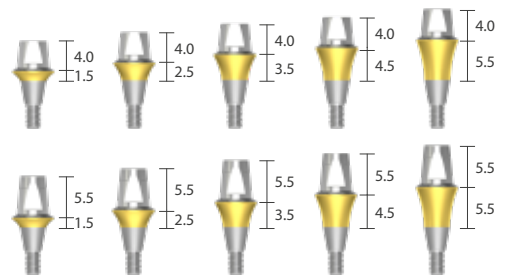

Ø 6.5	1.5	Short	CAB 65 15 S	Long	CAB 65 15
	2.5		CAB 65 25 S		CAB 65 25
	3.5		CAB 65 35 S		CAB 65 35
	4.5		CAB 65 45 S		CAB 65 45
	5.5		CAB 65 55 S		CAB 65 55

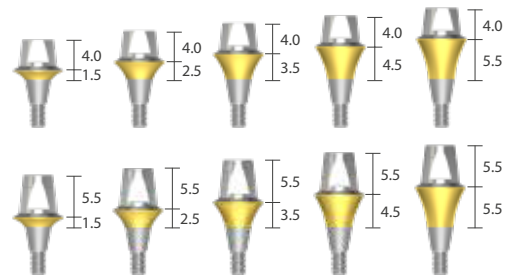

※ Hex driver: It is recommended to keep the torque level at 30~35 N·cm to tighten Combi Abutment with fixture.

Dual Abutment [Hex]

Unit: mm, Scale 1.5 : 1

· Abutment screw is included

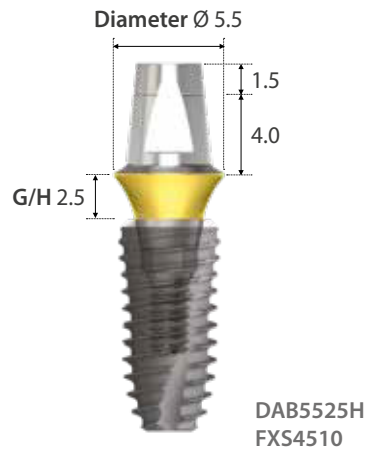

Diameter	G/H	Art. No.
Ø 4.5	1.0	DAB 45 10 H
	1.5	DAB 45 15 H
	2.5	DAB 45 25 H
	3.5	DAB 45 35 H
	4.5	DAB 45 45 H
	5.5	DAB 45 55 H
Ø 5.5	1.5	DAB 55 15 H
	2.5	DAB 55 25 H
	3.5	DAB 55 35 H
	4.5	DAB 55 45 H
	5.5	DAB 55 55 H
Ø 6.5	1.5	DAB 65 15 H
	2.5	DAB 65 25 H
	3.5	DAB 65 35 H
	4.5	DAB 65 45 H
	5.5	DAB 65 55 H

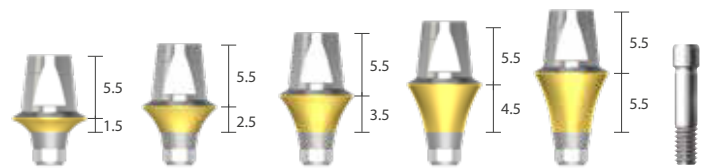
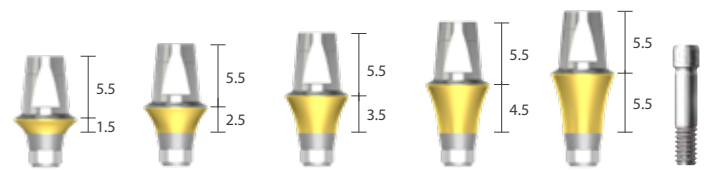
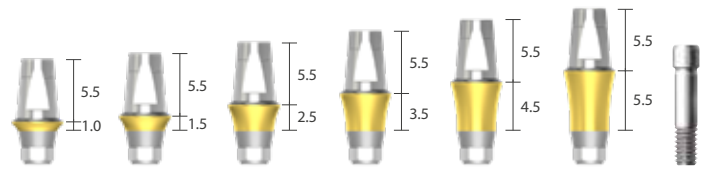

※ Hex driver: It is recommended to keep the torque level at 30~35 N·cm to tighten Dual Abutment with fixture.

Dual Abutment [Non-hex]

Unit: mm, Scale 1.5 : 1

· Abutment screw is included

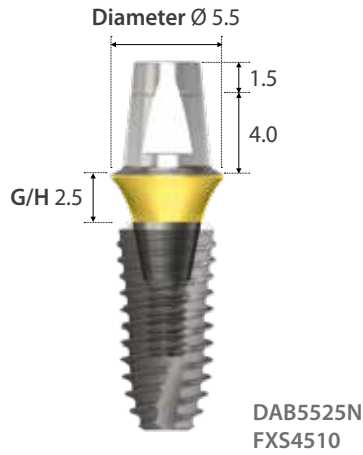

Diameter	G/H	Art. No.
Ø 4.5	1.0	DAB 45 10 N
	1.5	DAB 45 15 N
	2.5	DAB 45 25 N
	3.5	DAB 45 35 N
	4.5	DAB 45 45 N
	5.5	DAB 45 55 N
Ø 5.5	1.5	DAB 55 15 N
	2.5	DAB 55 25 N
	3.5	DAB 55 35 N
	4.5	DAB 55 45 N
	5.5	DAB 55 55 N
Ø 6.5	1.5	DAB 65 15 N
	2.5	DAB 65 25 N
	3.5	DAB 65 35 N
	4.5	DAB 65 45 N
	5.5	DAB 65 55 N

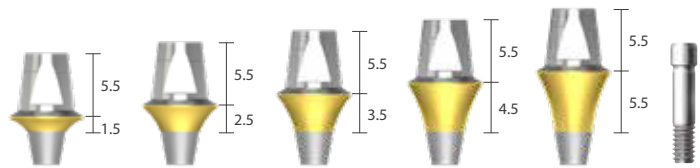
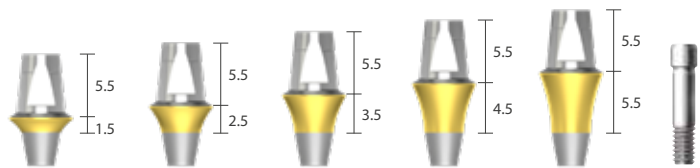
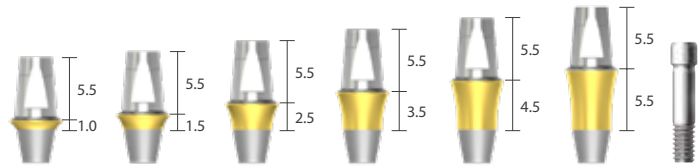

※ Hex driver: It is recommended to keep the torque level at 30~35 N·cm to tighten Dual Abutment with fixture.

Abutment Level Impression Components

Unit: mm, Scale 1 : 1

Comfort Cap | Snap on

Type	Diameter	Art. No.
Short	Ø 4.5	CCC 45 CS
	Ø 5.5	CCC 55 CS
	Ø 6.5	CCC 65 CS
Long	Ø 4.5	CCC 45 C
	Ø 5.5	CCC 55 C
	Ø 6.5	CCC 65 C

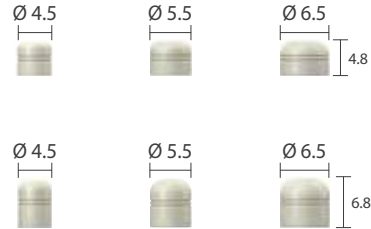

Impression Coping | Snap on

Diameter	Art. No.
Ø 4.5	CIC 45 L
Ø 5.5	CIC 55 L
Ø 6.5	CIC 65 L



Lab Analog

Type	Diameter	Art. No.
Short	Ø 4.5	CAN 45 SL
	Ø 5.5	CAN 55 SL
	Ø 6.5	CAN 65 SL
Long	Ø 4.5	CAN 45 LL
	Ø 5.5	CAN 55 LL
	Ø 6.5	CAN 65 LL

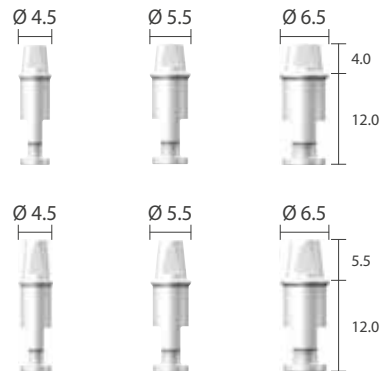

Burn-out Cylinder

Type	Diameter	Art. No.
Single	Ø 4.5	CBC 45 SL
	Ø 5.5	CBC 55 SL
	Ø 6.5	CBC 65 SL
Bridge	Ø 4.5	CBC 45 BL
	Ø 5.5	CBC 55 BL
	Ø 6.5	CBC 65 BL



Restorative Kit



Combi & Dual Abutment

Art. No	Lab. Components				
	Comfort Cap	Impression Coping	Analog	Burn-out Cylinder	
XSDAB 45 S XSDAB 45	CCC 45 CS CCC 45 C	CIC 45 L	CAN 45 SL CAN 45 LL	CBC 45 SL	CBC 45 BL
XSDAB 55 S XSDAB 55	CCC 55 CS CCC 55 C	CIC 55 L	CAN 55 SL CAN 55 LL	CBC 55 SL	CBC 55 BL
XSDAB 65 S XSDAB 65	CCC 65 CS CCC 65 C	CIC 65 L	CAN 65 SL CAN 65 LL	CBC 65 SL	CBC 65 BL

Prosthetic Procedure 2

Impression Technique and Restoration Selection

Dual / Custom / Milling / Angled / Direct-Casting / Metal-Casting /
Ti-Temporary / Plastic Temporary Abutment

Fixture Level Impression

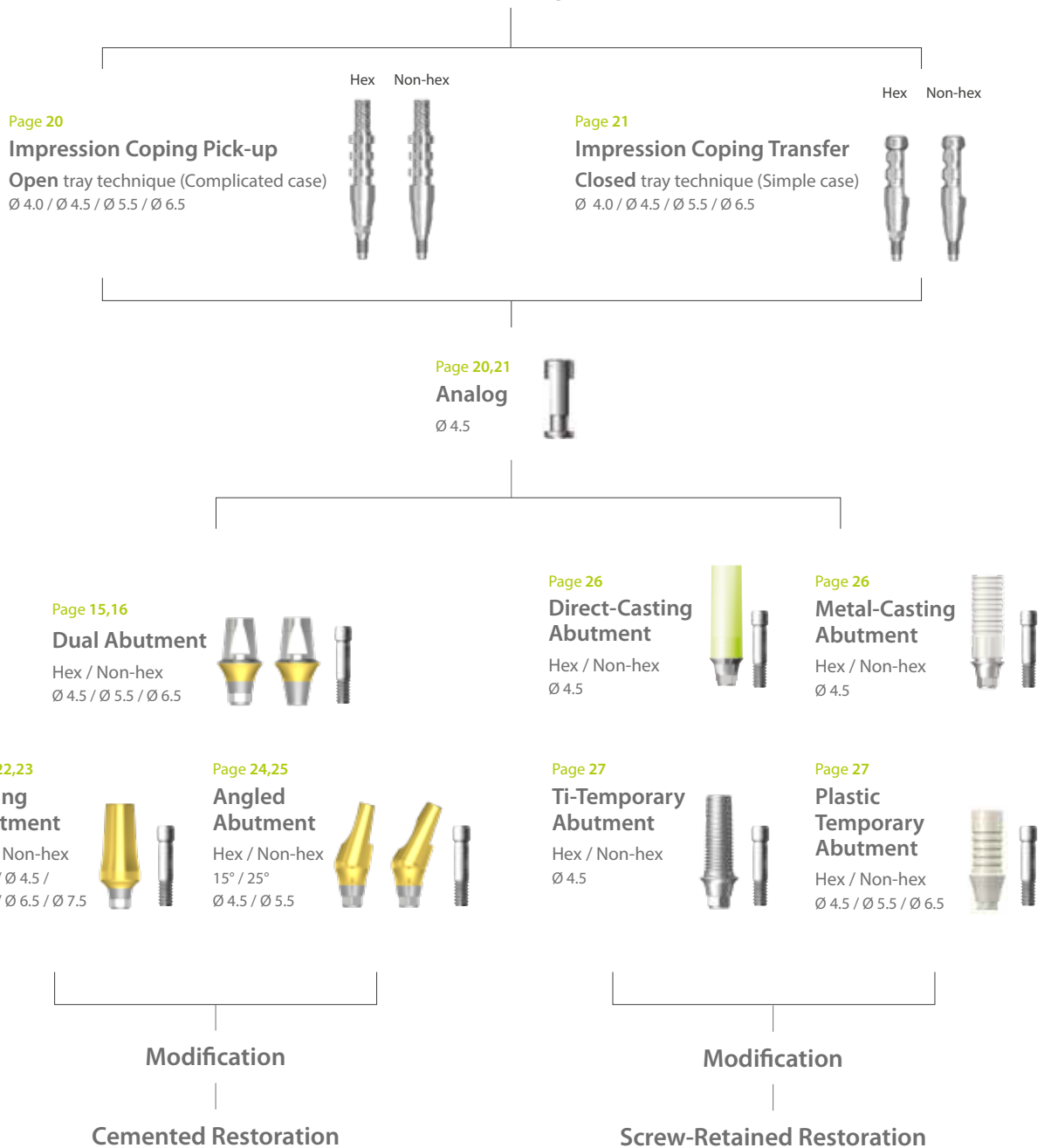

Fixture Level Impression Components

Unit: mm, Scale 1 : 1

· Impression coping screw is included with Impression coping.

Impression Coping Pick-up

Diameter	Size	Type	Art. No.
Ø 4.0	Short	Hex	DPU 40 11 HE
	Short	Non-hex	DPU 40 11 NE
	Long	Hex	DPU 40 15 HE
	Long	Non-hex	DPU 40 15 NE

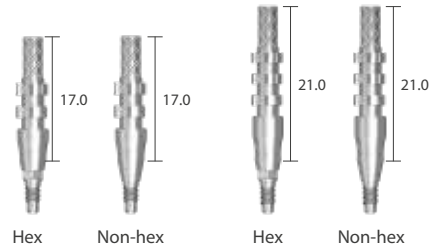

Ø 4.5	Short	Hex	DPU 45 11 HE
	Short	Non-hex	DPU 45 11 NE
	Long	Hex	DPU 45 15 HE
	Long	Non-hex	DPU 45 15 NE

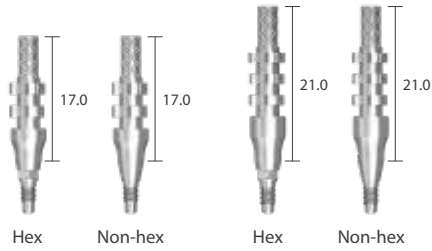

Ø 5.5	Short	Hex	DPU 55 11 HE
	Short	Non-hex	DPU 55 11 NE
	Long	Hex	DPU 55 15 HE
	Long	Non-hex	DPU 55 15 NE

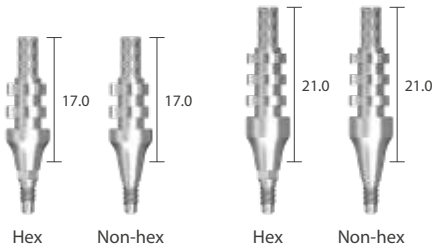

Ø 6.5	Short	Hex	DPU 65 11 HE
	Short	Non-hex	DPU 65 11 NE
	Long	Hex	DPU 65 15 HE
	Long	Non-hex	DPU 65 15 NE

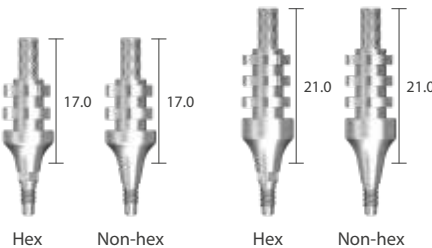

Impression Coping Transfer Screw

Size	L	Art. No.
Short	23.0	DPS 11 E
Long	27.0	DPS 15 E

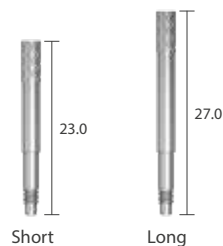

Analog

Diameter	L	Art. No.
Ø 4.5	12.0	DANSE

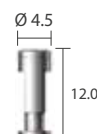

Fixture Level Impression Components

Unit: mm, Scale 1 : 1

· Impression coping screw is included with Impression coping.

Impression Coping Transfer

Diameter	Size	Type	Art. No.
Ø 4.0	Short	Hex	DTF 40 11 HE
	Short	Non-hex	DTF 40 11 NE
	Long	Hex	DTF 40 15 HE
	Long	Non-hex	DTF 40 15 NE

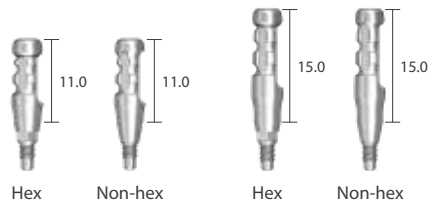

Ø 4.5	Short	Hex	DTF 45 11 HE
	Short	Non-hex	DTF 45 11 NE
	Long	Hex	DTF 45 15 HE
	Long	Non-hex	DTF 45 15 NE

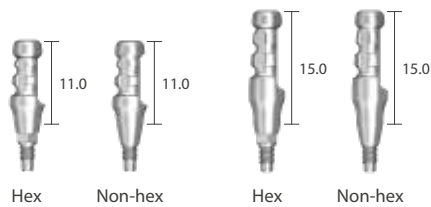

Ø 5.5	Short	Hex	DTF 55 11 HE
	Short	Non-hex	DTF 55 11 NE
	Long	Hex	DTF 55 15 HE
	Long	Non-hex	DTF 55 15 NE

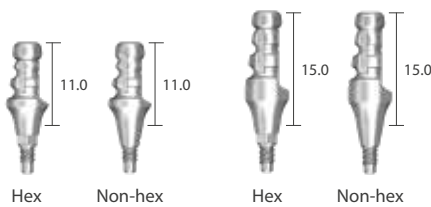

Ø 6.5	Short	Hex	DTF 65 11 HE
	Short	Non-hex	DTF 65 11 NE
	Long	Hex	DTF 65 15 HE
	Long	Non-hex	DTF 65 15 NE

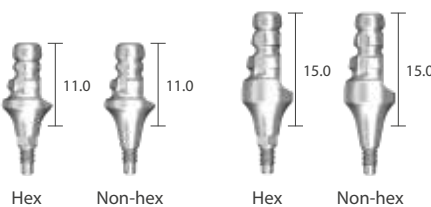

Impression Coping Transfer Screw

Size	L	Art. No.
Short	17.0	DTS 11 E
Long	21.0	DTS 15 E

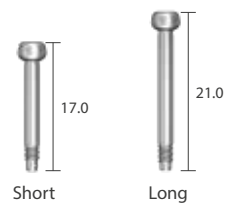

Analog

Diameter	L	Art. No.
Ø 4.5	12.0	DANSE

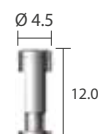

Milling Abutment

Unit: mm, Scale 1.5 : 1

· Abutment screw is included.



Diameter	G/H	Type	Art. No.
\varnothing 4.0	1.0	Hex	MAB 40 105 H
	1.0	Non-hex	MAB 40 105 N

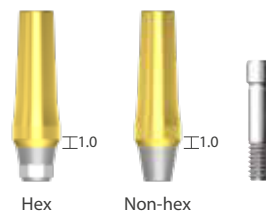

Diameter	G/H	Type	Art. No.
\varnothing 4.5	1.5	Hex	MAB 45 156 H
	1.5	Non-hex	MAB 45 156 N

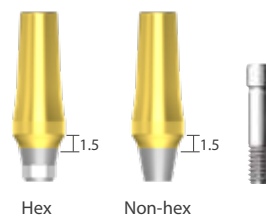

Diameter	G/H	Type	Art. No.
\varnothing 5.5	1.5	Hex	MAB 55 157 H
	1.5	Non-hex	MAB 55 157 N
	2.5	Hex	MAB 55 257 H
	2.5	Non-hex	MAB 55 257 N

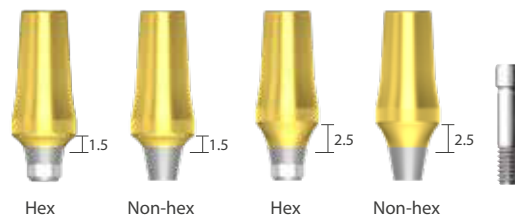

※ Hex driver: It is recommended to keep the torque level at 30~35 N·cm to tighten Milling Abutment with fixture.

Milling Abutment

Unit: mm, Scale 1.5 : 1

· Abutment screw is included.

Diameter	G/H	Type	Art. No.
Ø 6.5	1.5	Hex	MAB 65 158 H
	1.5	Non-hex	MAB 65 158 N
	2.5	Hex	MAB 65 258 H
	2.5	Non-hex	MAB 65 258 N
	3.5	Hex	MAB 65 358 H
	3.5	Non-hex	MAB 65 358 N

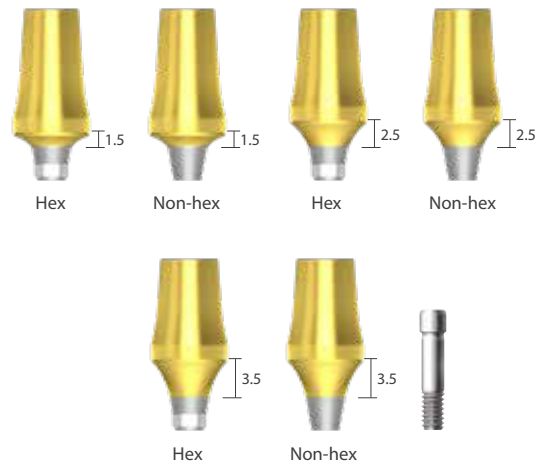

Diameter	G/H	Type	Art. No.
Ø 7.5	2.5	Hex	MAB 75 259 H
	2.5	Non-hex	MAB 75 259 N
	3.5	Hex	MAB 75 359 H
	3.5	Non-hex	MAB 75 359 N



※ Hex driver: It is recommended to keep the torque level at 30~35 N·cm to tighten Milling Abutment with fixture.

Angled Abutment [15°]

Unit: mm, Scale 1.5 : 1

· Abutment screw is included.

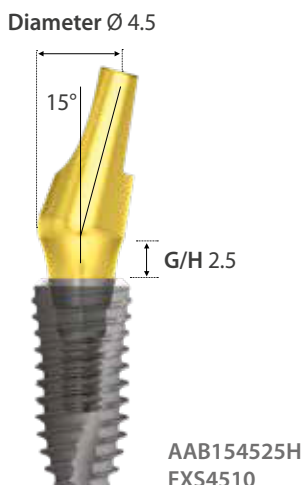

Diameter	G/H	Type	Art. No.
\varnothing 4.5	1.5	Hex	AAB 15 45 15 H
	1.5	Non-hex	AAB 15 45 15 N
	2.5	Hex	AAB 15 45 25 H
	2.5	Non-hex	AAB 15 45 25 N
	3.5	Hex	AAB 15 45 35 H
	3.5	Non-hex	AAB 15 45 35 N

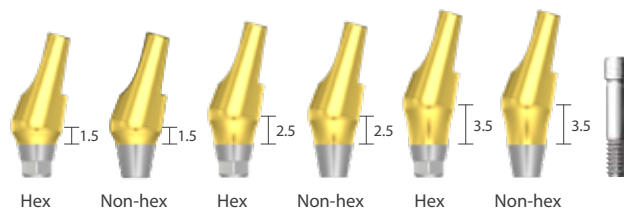

Diameter	G/H	Type	Art. No.
\varnothing 5.5	1.5	Hex	AAB 15 55 15 H
	1.5	Non-hex	AAB 15 55 15 N
	2.5	Hex	AAB 15 55 25 H
	2.5	Non-hex	AAB 15 55 25 N
	3.5	Hex	AAB 15 55 35 H
	3.5	Non-hex	AAB 15 55 35 N

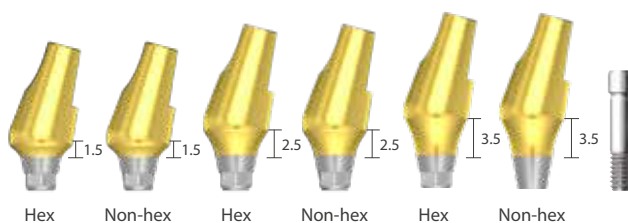

※ Hex driver: It is recommended to keep the torque level at 30~35 N·cm to tighten Angled Abutment with fixture.

Angled Abutment [25°]

Unit: mm, Scale 1.5 : 1

· Abutment screw is included.

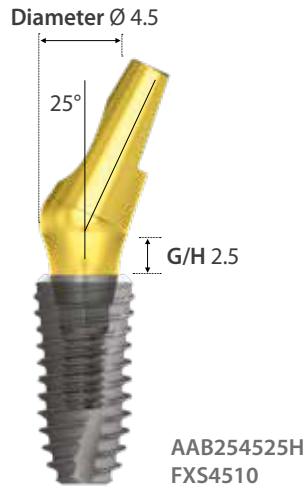

Diameter	G/H	Type	Art. No.
\varnothing 4.5	1.5	Hex	AAB 25 45 15 H
	1.5	Non-hex	AAB 25 45 15 N
	2.5	Hex	AAB 25 45 25 H
	2.5	Non-hex	AAB 25 45 25 N
	3.5	Hex	AAB 25 45 35 H
	3.5	Non-hex	AAB 25 45 35 N

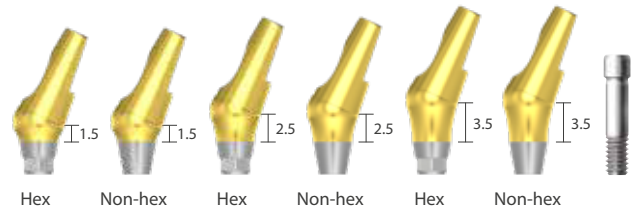

Diameter	G/H	Type	Art. No.
\varnothing 5.5	1.5	Hex	AAB 25 55 15 H
	1.5	Non-hex	AAB 25 55 15 N
	2.5	Hex	AAB 25 55 25 H
	2.5	Non-hex	AAB 25 55 25 N
	3.5	Hex	AAB 25 55 35 H
	3.5	Non-hex	AAB 25 55 35 N



※ Hex driver: It is recommended to keep the torque level at 30~35 N·cm to tighten Angled Abutment with fixture.

Direct-Casting Abutment

Unit: mm, Scale 1.5 : 1

• Abutment screw is included.

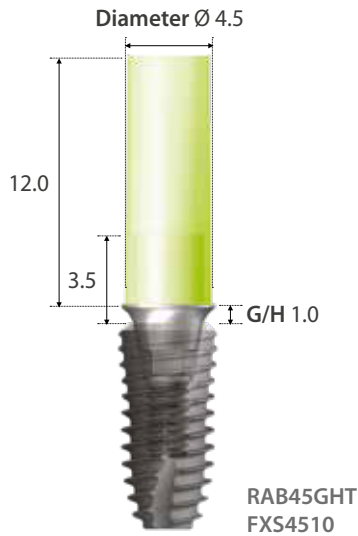

Gold

Diameter	G/H	Type	Art. No.
Ø 4.5	1.0	Hex	RAB 45 GHT
		Non-hex	RAB 45 GNT

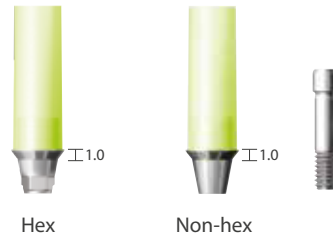

Metal-Casting Abutment

Unit: mm, Scale 1.5 : 1

• Abutment screw is included.



Co-Cr

Diameter	G/H	Type	Art. No.
Ø 4.5	1.0	Hex	RAB 45 CLH
		Non-hex	RAB 45 CLN

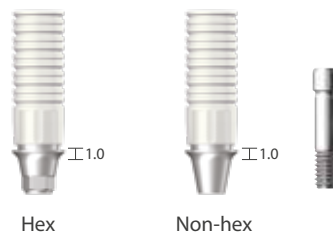

※ Hex driver: It is recommended to keep the torque level at 30~35 N·cm to tighten Direct/Metal Casting Abutment with fixture.

Ti-Temporary Abutment

• Abutment screw is included.

Unit: mm, Scale 1.5 : 1

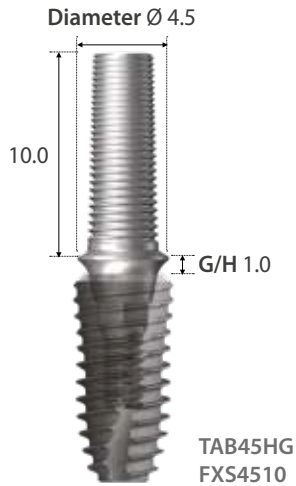

Diameter	G/H	Type	Art. No.
Ø 4.5	1.0	Hex	TAB 4510 HG
		Non-hex	TAB 4510 NG
	3.0	Hex	TAB 4530 HG
		Non-hex	TAB 4530 NG



Plastic Temporary Abutment

• Abutment screw is included.

Unit: mm, Scale 1.5 : 1



Diameter	G/H	Type	Art. No.
Ø 4.5	2.0	Hex	RAB 45 20 PHL
		Non-hex	RAB 45 20 PNL
Ø 5.5	2.0	Hex	RAB 55 20 PHL
		Non-hex	RAB 55 20 PNL
Ø 6.5	2.0	Hex	RAB 65 20 PHL
		Non-hex	RAB 65 20 PNL

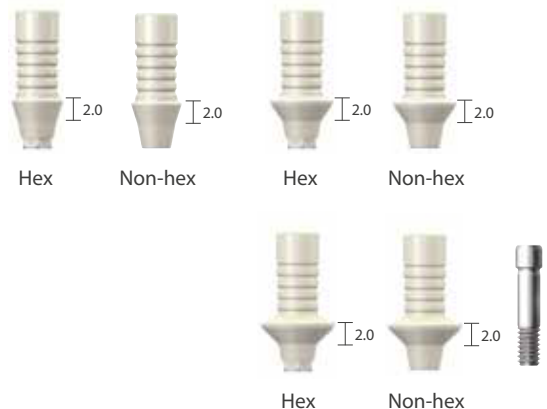

※ Hex driver: It is recommended to keep the torque level at 15~20 N-cm to tighten Temporary Abutment with fixture.

Prosthetic Procedure 3

Impression Technique and Restoration Selection

Screw Abutment

Abutment Level Impression

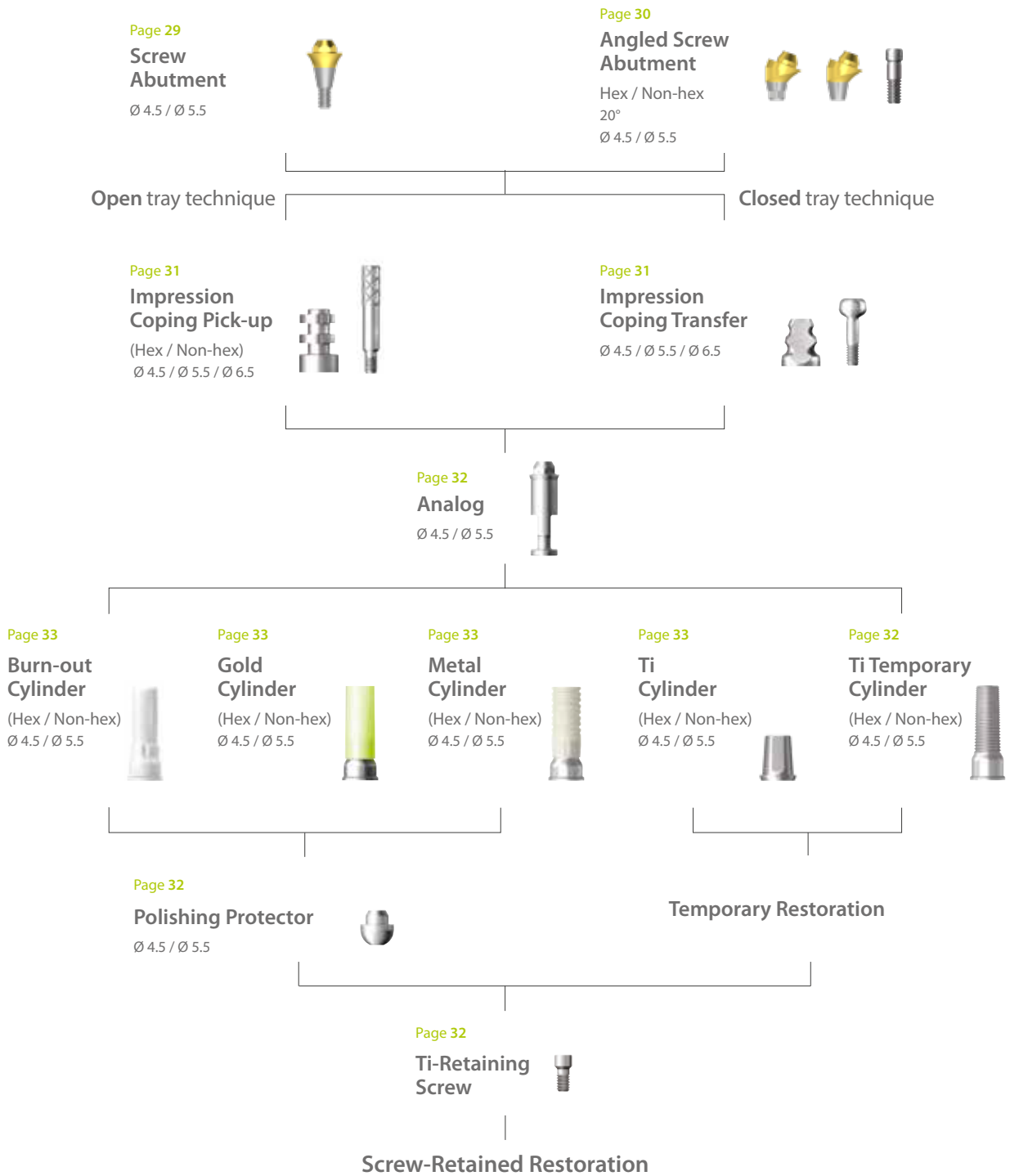

Screw Abutment

Unit: mm, Scale 1.5 : 1

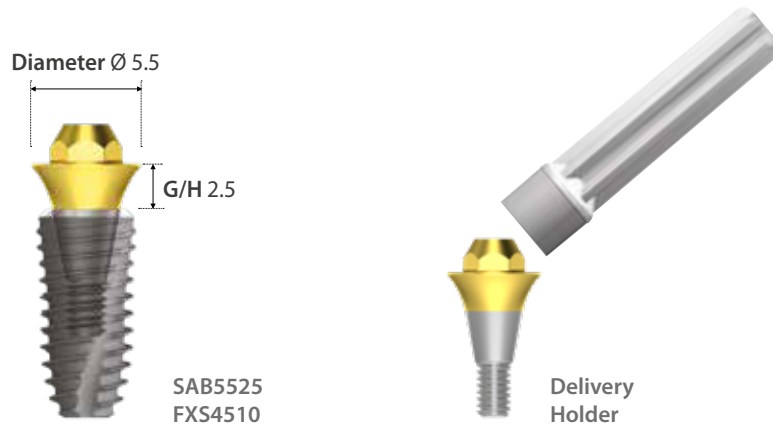

Diameter	G/H	Art. No.
Ø 4.5	1.0	SAB 45 10
	1.5	SAB 45 15
	2.5	SAB 45 25
	3.5	SAB 45 35
	4.5	SAB 45 45
	5.5	SAB 45 55

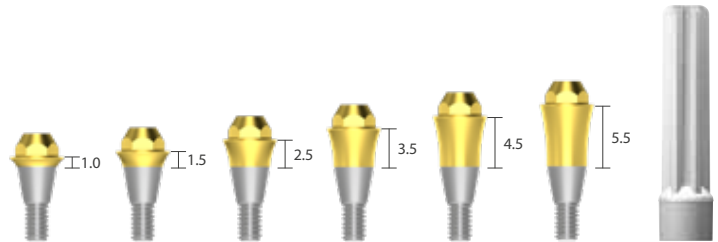

Diameter	G/H	Art. No.
Ø 5.5	1.5	SAB 55 15
	2.5	SAB 55 25
	3.5	SAB 55 35
	4.5	SAB 55 45
	5.5	SAB 55 55

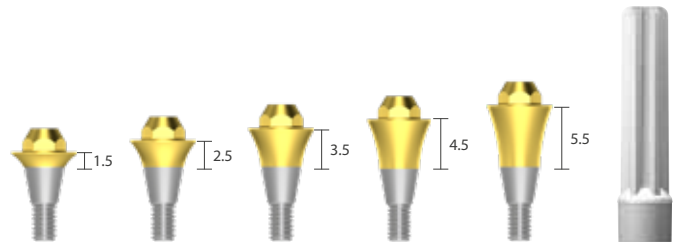

※ Hex driver: It is recommended to keep the torque level at 30~35 N-cm to tighten Screw Abutment with fixture.

Angled Screw Abutment

Unit: mm, Scale 1.5 : 1

· Abutment screw is included.

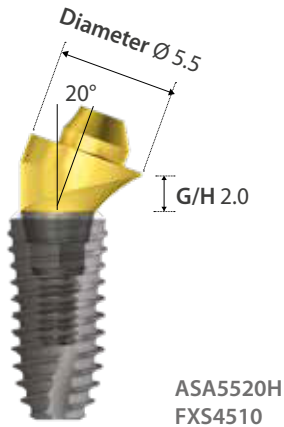

Diameter	G/H	Type	Art. No.
\varnothing 4.5	1.0	Hex	ASA 45 10 H
	1.0	Non-hex	ASA 45 10 N
	2.0	Hex	ASA 45 20 H
	2.0	Non-hex	ASA 45 20 N
	3.0	Hex	ASA 45 30 H
	3.0	Non-hex	ASA 45 30 N

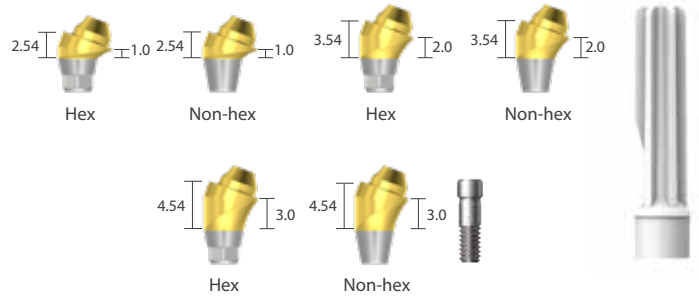

Diameter	G/H	Type	Art. No.
\varnothing 5.5	1.0	Hex	ASA 55 10 H
	1.0	Non-hex	ASA 55 10 N
	2.0	Hex	ASA 55 20 H
	2.0	Non-hex	ASA 55 20 N
	3.0	Hex	ASA 55 30 H
	3.0	Non-hex	ASA 55 30 N

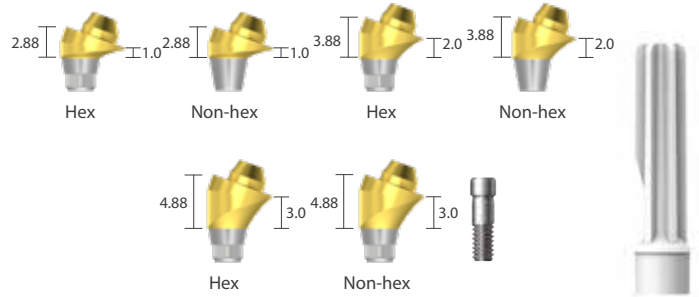

Angled Screw Abutment Screw

Diameter	L	Art. No.
\varnothing 2.3	7.3	ASASC 20 23

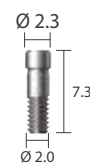

Ti-Delivery Holder

ASAH



※ Hex driver: It is recommended to keep the torque level at 30~35 N·cm to tighten Angled Screw Abutment with fixture.

Screw Abutment Impression Components

Unit: mm, Scale 1.5 : 1

Impression Coping Pick-up

Diameter	Type	Art. No.
Ø 4.5	Hex	SPU 45 SL
	Non-hex	SPU 45 BL
Ø 5.5	Hex	SPU 55 SL
	Non-hex	SPU 55 BL

Ø 4.5



Hex

Ø 4.5



Non-hex

Ø 5.5



Hex

Ø 5.5



Non-hex

Impression Coping Transfer

Diameter	Type	Art. No.
Ø 4.5	Hex	STF 45 SL
	Non-hex	STF 45 BL
Ø 5.5	Hex	STF 55 SL
	Non-hex	STF 55 BL

Ø 4.5



Hex

Ø 4.5



Non-hex

Ø 5.5



Hex

Ø 5.5



Non-hex

Impression Coping Screw

Type	L	Art. No.
Pick-up	15.0	SPS 09
Transfer	9.0	STS 09



15.0



9.0

Screw Abutment Components

Unit: mm, Scale 1.5 : 1

Comfort Cap

Diameter	L	Art. No.
Ø 4.5	5.0	SCC 45 L
Ø 5.5		SCC 55 L



Scan Comfort Cap | PEEK

Diameter	L	Art. No.	
Ø 4.5	5.0	Hex	ISC 45 SP
		Non-hex	ISC 45 BP
Ø 5.5		Hex	ISC 55 SP
		Non-hex	ISC 55 BP

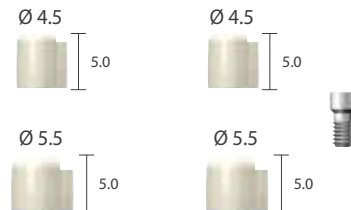

Analog

Diameter	L	Art. No.
Ø 4.5	12.0	SAN 45 L
Ø 5.5		SAN 55 L

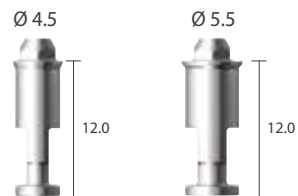

Polishing Protector

Diameter	L	Art. No.
Ø 4.5	4.71	SPP 45 L
Ø 5.5		SPP 55 L



Ti-Retaining Screw

Diameter	L	Art. No.
Ø 2.3	5.0	SRS 18 T

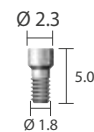

Ti-Temporary Cylinder

Diameter	Type	Art. No.
Ø 4.5	Hex	STC 45 SG
	Non-hex	STC 45 BG
Ø 5.5	Hex	STC 55 SG
	Non-hex	STC 55 BG

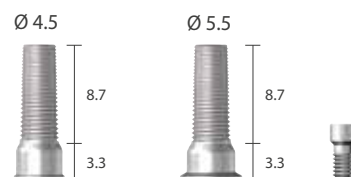

Screw Abutment Components

Unit: mm, Scale 1.5 : 1

Ti-Cylinder

Diameter	Type	Art. No.
Ø 4.5	Hex	STA 45 S
	Non-hex	STA 45 B
Ø 5.5	Hex	STA 55 S
	Non-hex	STA 55 B

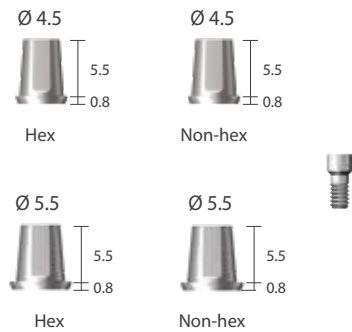

Gold Cylinder

Diameter	Type	Art. No.
Ø 4.5	Hex	SGC 45 SL
	Non-hex	SGC 45 BL
Ø 5.5	Hex	SGC 55 SL
	Non-hex	SGC 55 BL



Metal Cylinder | Co-Cr

Diameter	Type	Art. No.
Ø 4.5	Hex	SGC 45 CSL
	Non-hex	SGC 45 CBL
Ø 5.5	Hex	SGC 55 CSL
	Non-hex	SGC 55 CBL



Burn-out Cylinder

Diameter	Type	Art. No.
Ø 4.5	Hex	SBC 45 SL
	Non-hex	SBC 45 BL
Ø 5.5	Hex	SBC 55 SL
	Non-hex	SBC 55 BL

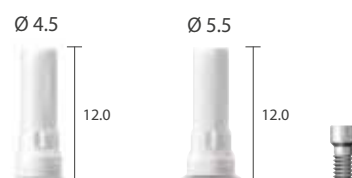

※ Hex driver: It is recommended to keep the torque level at 15~20 N-cm to tighten Screw Abutment Components with fixture.

Prosthetic Procedure 4

Impression Technique and Restoration Type

Overdenture Procedure

Positioner / Mini Ball / Magnetic Attachment

Page 35

Positioner Abutment

Ø 3.5



Page 37

Mini Ball Abutment

Ø 3.3 / Ø 3.5



Page 38,39

Magnetic Implant Keeper

Dome type / Flat type
Ø 4.5 / Ø 5.5



Abutment Level Impression

Page 35

Positioner Impression Coping

Ø 4.5



Page 37

Mini Ball Impression Coping

Ø 3.5



Page 35

Positioner Analog

Ø 3.5



Page 37

Mini Ball Analog

Ø 3.5



Page 37

Socket Spacer

Ø 4.05 / Ø 4.85



Page 36

Positioner Socket

Metal / Plastic

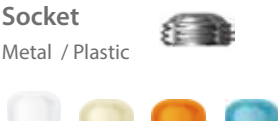

Page 37

Mini Ball Female Socket / O-ring

Ø 4.05 / Ø 4.85



Page 38,39

Magnetic Assay

Dome type / Flat type
Ø 4.5 / Ø 5.5



Positioner Attachment for Overdenture

Mini Ball and Socket Attachment for Overdenture

Magnetic Attachment for Overdenture

Positioner

Unit: mm, Scale 1.5 : 1

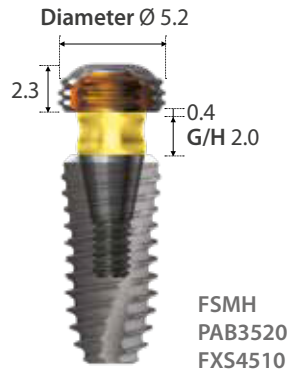

Positioner Abutment

Diameter	G/H	Art. No.
Ø 3.5	1.0	PAB 35 10
	2.0	PAB 35 20
	3.0	PAB 35 30
	4.0	PAB 35 40
	5.0	PAB 35 50
	6.0	PAB 35 60
	7.0	PAB 35 70

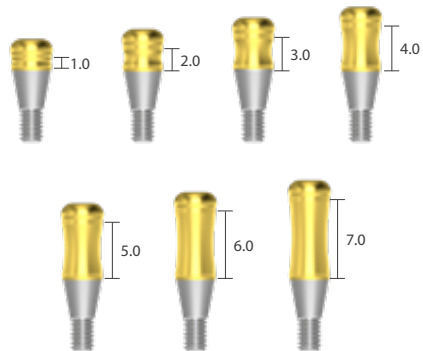

Positioner Impression Coping

Diameter	L	Art. No.
Ø 4.5	4.5	PIC



Positioner Analog

Diameter	L	Art. No.
Ø 3.5	12.4	PAN

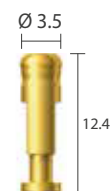

※ Hex driver: It is recommended to keep the torque level at 30~35 N-cm to tighten Positioner Abutment with fixture.

Positioner

Unit: mm, Scale 1.5 : 1

Positioner Socket Set

Type	Art. No.
Tilting type $\pm 10^\circ$	FSMHS
Non Tilting type $\pm 5^\circ$	FSMHSN



Positioner Metal Socket

Diameter	H	Art. No.
$\varnothing 5.2$	2.3	FSMH

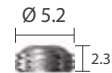

Plastic Scket

Type	Application	Art. No.
Tilting type $\pm 10^\circ$	Blue 1,000gf	MSHP
	Orange 500gf	MSMP
	Ivory 300gf	MSLP
	White 100gf	MSOP
Non tilting type $\pm 5^\circ$	Blue 1000gf	MSHPN
	Orange 500gf	MSMPN
	Ivory 300gf	MSLPN
	White 100gf	MSOPN

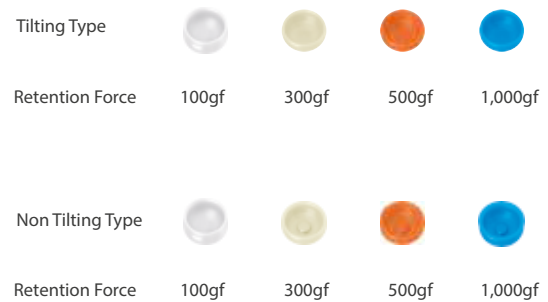

Block Out Spacer

Diameter	H	Art. No.
$\varnothing 6.5$	0.5	BOS



Positioner Core Tool

XPCT



Mini Ball Attachment

Unit: mm, Scale 1.5 : 1



Mini Ball Abutment

Diameter	G/H	Art. No.
Ø 3.3	0	BAB 35 00 18
Ø 3.5	1.0	BAB 35 10 18
Ø 3.5	2.0	BAB 35 20 18
Ø 3.5	3.0	BAB 35 30 18
Ø 3.5	4.0	BAB 35 40 18
Ø 3.5	5.0	BAB 35 50 18

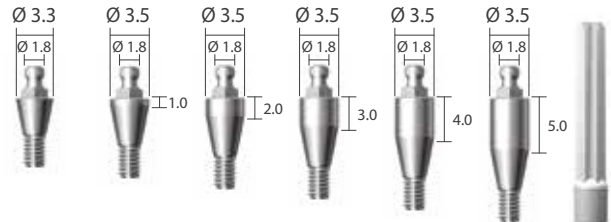

Mini Ball Impression Coping

Diameter	L	Art. No.
Ø 3.4	4.2	GICA

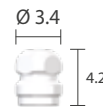

Mini Ball Analog

Diameter	Art. No.
Ø 3.5	BANL



Socket Spacer

Diameter	Art. No.
Ø 4.05	GBIC 3 L
Ø 4.85	GBIC 2 L



Female Socket

Diameter	Retention Force	Art. No.
Ø 4.05	300~500gf	BPF 3
Ø 4.85	500~700gf	BPF 2



Block Out Spacer

Diameter	H	Art. No.
Ø 6.5	0.5	BOS



※ Hex driver: It is recommended to keep the torque level at 30~35 N-cm to tighten Mini Ball Abutment with fixture.

Magnetic Attachment [Dome Type]

Unit: mm, Scale 1.5 : 1



MGT4520D
MKP4520D
FXS4510

Magnetic Assay

Application	Diameter	H	Art. No.
MKP45D	Ø 4.5	2.0	MGT 45 20 D
MKP55D	Ø 5.5	2.0	MGT 55 20 D

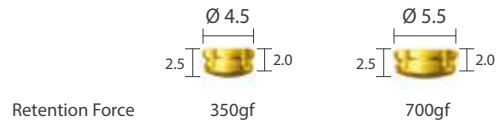

Implant Keeper Diameter

Diameter	G/H	Art. No.
Ø 4.5	1.0	MKP 45 10 D
	2.0	MKP 45 20 D
	3.0	MKP 45 30 D
	4.0	MKP 45 40 D
	5.0	MKP 45 50 D
	6.0	MKP 45 60 D
Ø 5.5	1.0	MKP 55 10 D
	2.0	MKP 55 20 D
	3.0	MKP 55 30 D
	4.0	MKP 55 40 D
	5.0	MKP 55 50 D
	6.0	MKP 55 60 D

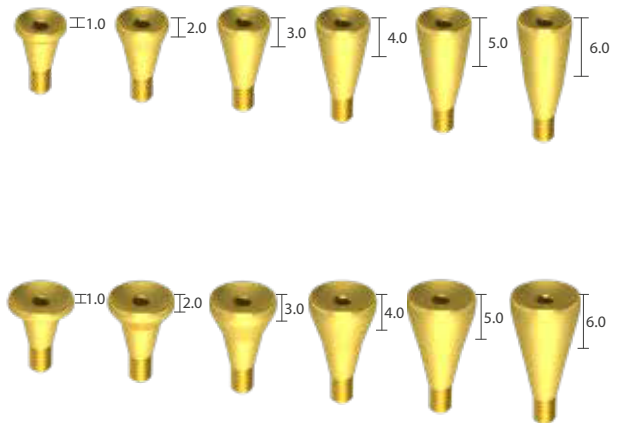

※ Hex driver: It is recommended to keep the torque level at 30~35 N·cm to tighten Magnetic Abutment with fixture.

Magnetic Attachment [Flat Type]

Unit: mm, Scale 1.5 : 1



Magnetic Assay

Application	Diameter	H	Art. No.
MKP 45	Ø 4.5	1.5	MGT 45 15
	Ø 4.5	2.0	MGT 45 20
MKP 55	Ø 5.5	1.5	MGT 55 15
	Ø 5.5	2.0	MGT 55 20

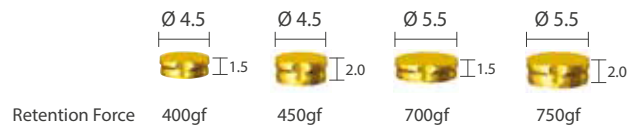

Implant Keeper Diameter

Diameter	G/H	Art. No.
Ø 4.5	1.0	MKP 45 10
	2.0	MKP 45 20
	3.0	MKP 45 30
	4.0	MKP 45 40
	5.0	MKP 45 50
	6.0	MKP 45 60
Ø 5.5	1.0	MKP 55 10
	2.0	MKP 55 20
	3.0	MKP 55 30
	4.0	MKP 55 40
	5.0	MKP 55 50
	6.0	MKP 55 60

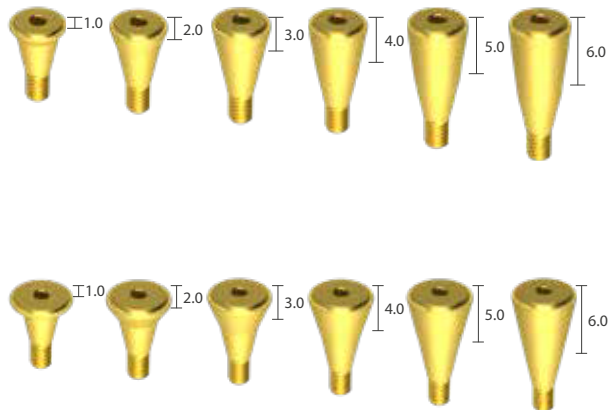

Block Out Spacer

Diameter	H	Art. No.
Ø 6.5	0.5	BOS



※ Hex driver: It is recommended to keep the torque level at 30~35 N-cm to tighten Implant Keeper with fixture.

Surgical Kit [Full]

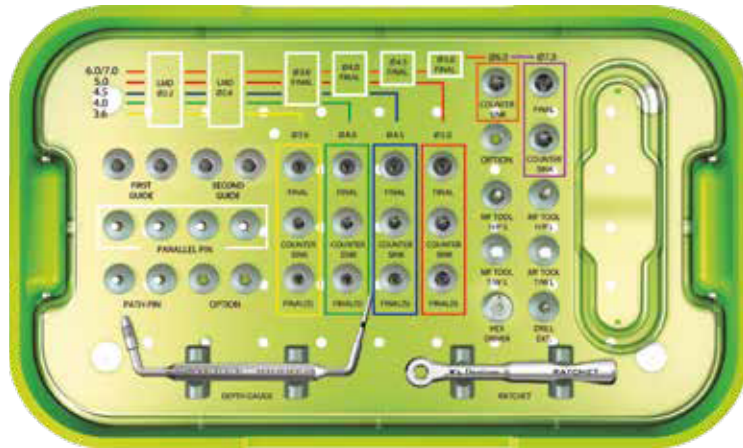

SuperLine Surgical Full Kit

UXNF

Kit Includes

First Guide Drill



XLD2229 XLD2235 (Stopper) XLD2629 XLD2635 (Stopper)

Second Guide Drill



XFD3435 XFD3835

Final Drill



XFD4335 XFD4835

Hand-piece Adapter



XFD5831 XFA27H XFA32H

Parallel Pin



XPP162220T

Countersink



XCS3629SW XCS4029SW XCS4529SW XCS5029SW XCS6029SW XCS7029SW

Ratchet Adapter



XFA26W XFA32W

MF Path Pin



XMFPA2

Final Drill(s)



XFD3429 XFD3829 XFD4329 XFD4829

Hex Driver Drill Extension



XHD26T XDE

Depth Gauge



XDGL

Ratchet



XRC A1

Surgical Kit [Stopper Drill Full]



Stopper Drill Full Kit

UXSF

Kit Includes

First Guide Drill



XLD2208S

Second Guide Drill



XLD2608S

Final Drill



XFD3408S



XFD3808S



XFD4308S



XFD4808S

Hand-piece Adapter



XFD5831



XFA27H



XFA32H



XLD2210S



XLD2610S



XFD3410S



XFD3810S



XFD4310S



XFD4810S

Ratchet Adapter



XFA26W



XFA32W



XLD2212S



XLD2612S



XFD3412S



XFC3812S



XFD4312S



XFD4812S

HexDriver



XHD26T



XDE

Drill Extension



XPP162220T



XFC3607



XFC4007



XFC4507



XFC5007



XFC6007



XFC7007

Hand-piece Ratchet



XHD25H



XHD25W

MF Path Pin



XMFPA2

Depth Gauge



XDGL

Torque Wrench



XNTW

Surgical Kit [Standard]



SuperLine Surgical Standard Kit

UXNS

Kit Includes

First Guide Drill



XLD2231



XFD3431



XFD3831



XFD4331



XFD4831



XFD5831

Final Drill

Second Guide Drill



XLD2631



XCS3629SW



XCS4029SW



XCS4529SW



XCS5029SW



XCS7029SW

Countersink

Ratchet



XRCA1

Parallel Pin



XPP162220T



XPP162226T

MF Path Pin



XMFPA2



XMFPA2

Hex Driver (Hand-piece)



XHD25H



XHD26T



XCS6029SW

Hex Driver

Drill Extension



XDE

Hand-piece Adapter



XFA30H



XFA26W

Ratchet Adapter

Surgical Kit [Short Implant]

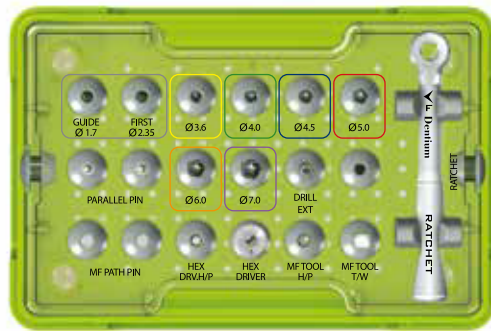

SuperLine Short Implant Surgical Kit

XSIIK

Kit Includes

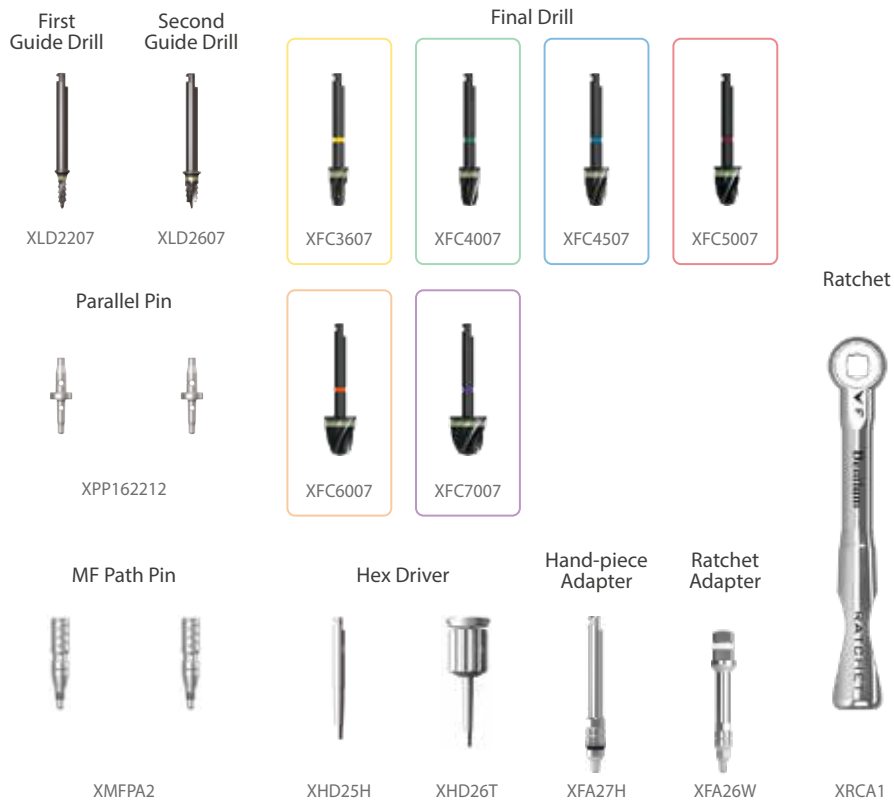



















Surgical Kit [Stopper Drill Kit]



Stopper Drill Kit

XSDK

Kit Includes

	First Guide Drill	Second Guide Drill	Final Drill			
L8	 XLD2208S	 XLD2608S	 XFD3408S	 XFD3808S	 XFD4308S	 XFD4808S
L10	 XLD2210S	 XLD2610S	 XFD3410S	 XFD3810S	 XFD4310S	 XFD4810S
L12	 XLD2212S	 XLD2612S	 XFD3412S	 XFD3812S	 XFD4312S	 XFD4812S

Surgical Kit [Drill Stopper Kit]

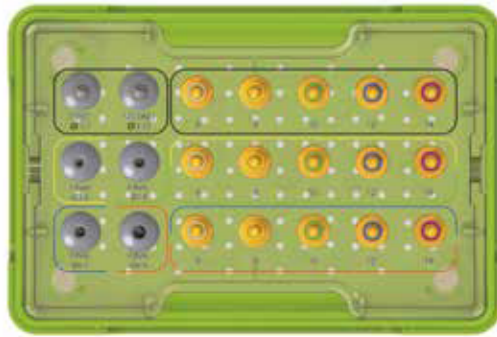

Drill Stopper Kit

XDS

Kit Includes

Guide Drill Stopper
First Second

XLD2235 XLD2635

Stopper - First Guide Drill, Second Guide Drill

XLDST06 XLDST08 XLDST10 XLDST12 XLDST14

Final Drill Stopper
34 38

XFD3435 XFD3835

Stopper - Final Drill / 34, 38

XFDST06 XFDST08 XFDST10 XFDST12 XFDST14

Final Drill Stopper
43 48

XFD4335 XFD4835

Stopper - Final Drill / 43, 48

XFDST06L XFDST08L XFDST10L XFDST12L XFDST14L

Surgical Instruments

Unit: mm, Scale 1 : 1

First Guide Drill

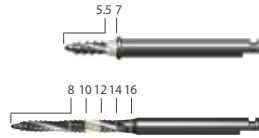

Diameter	L	Art. No.
Ø 2.2	26	XLD 22 07
	29	XLD 22 29
	31	XLD 22 31
	33	XLD 22 33
	35	XLD 22 35
	41	XLD 22 41

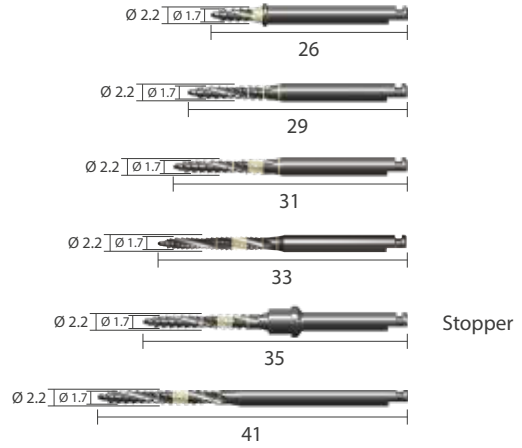

Second Guide Drill

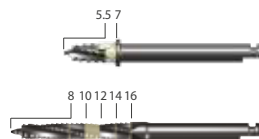

Diameter	L	Art. No.
Ø 2.6	26	XLD 26 07
	29	XLD 26 29
	31	XLD 26 31
	33	XLD 26 33
	35	XLD 26 35
	41	XLD 26 41

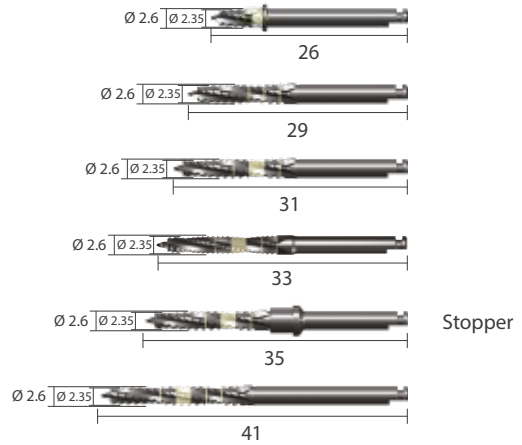

※ Note: Drill speed 1,000rpm, 30~45 N-cm with irrigation

Surgical Instruments

Unit: mm, Scale 1 : 1

Final Drill

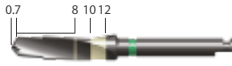

Diameter	L	Art. No.
Ø 2.9	29	XFD 34 29
Ø 3.35		XFD 38 29
Ø 3.85		XFD 43 29
Ø 4.4		XFD 48 29
Ø 5.4		XFD 58 29 SW

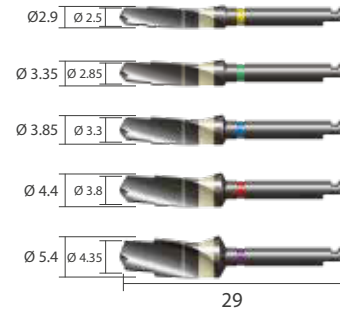

Final Drill



Diameter	L	Art. No.
Ø 2.9	31	XFD 34 31
Ø 3.35		XFD 38 31
Ø 3.85		XFD 43 31
Ø 4.4		XFD 48 31
Ø 5.4		XFD 58 31

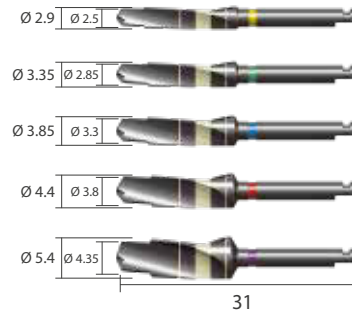

Final Drill



Diameter	L	Art. No.
Ø 2.9	33	XFD 34 33
Ø 3.35		XFD 38 33
Ø 3.85		XFD 43 33
Ø 4.4		XFD 48 33

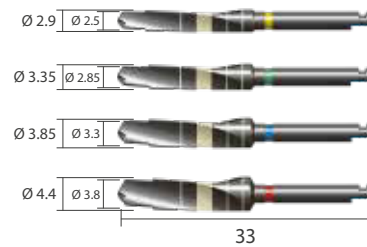

※ Note: Drill speed 1,000rpm, 30~45 N-cm with irrigation

Surgical Instruments

Unit: mm, Scale 1 : 1

Final Drill | Stopper 

Diameter	L	Art. No.
Ø 2.9	35	XFD 34 35
Ø 3.35		XFD 38 35
Ø 3.85		XFD 43 35
Ø 4.4		XFD 48 35

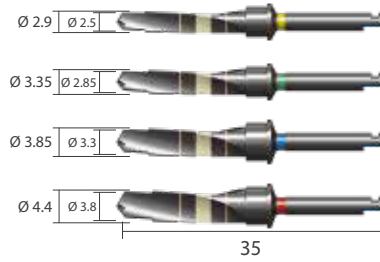

Final Drill 

Diameter	L	Art. No.
Ø 2.9	41	XFD 34 41
Ø 3.35		XFD 38 41
Ø 3.85		XFD 43 41
Ø 4.4		XFD 48 41

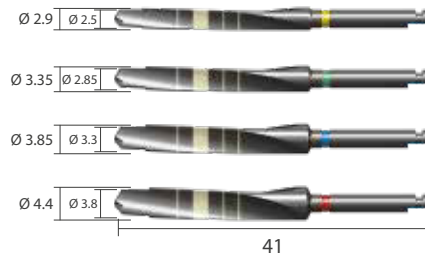

Harvest Drill | Stopper 

Diameter	L	Art. No.
Ø 2.85	35	XFH 34 35
Ø 3.3		XFH 38 35
Ø 3.85		XFH 43 35
Ø 4.4		XFH 48 35



Final Drill | For Short Implant 

Diameter	L	Art. No.
Ø 3.6	27	XFC 36 07
Ø 4.0		XFC 40 07
Ø 4.5		XFC 45 07
Ø 5.0		XFC 50 07
Ø 6.0		XFC 60 07
Ø 7.0		XFC 70 07

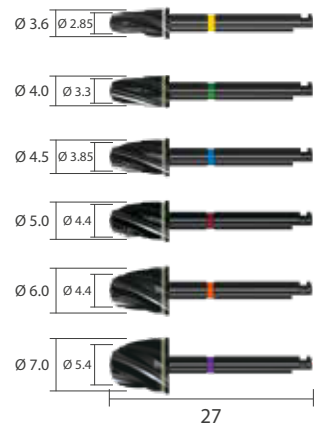

Surgical Instruments

Unit: mm, Scale 1 : 1

First I Stopper Drill

Diameter	L	Art. No.
Ø 2.20	8	XLD 2208S
	10	XLD 2210S
	12	XLD 2212S
	14	XLD 2214S

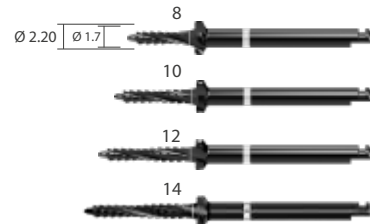

Second I Stopper Drill

Diameter	L	Art. No.
Ø 2.60	8	XLD 2608S
	10	XLD 2610S
	12	XLD 2612S
	14	XLD 2614S

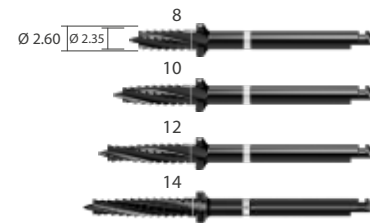

Final I Stopper Drill

Diameter	L	Art. No.
Ø 3.10	8	XFD 3408S
	10	XFD 3410S
	12	XFD 3412S
	14	XFD 3414S

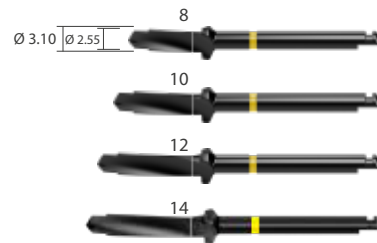

Diameter	L	Art. No.
Ø 3.55	8	XFD 3808S
	10	XFD 3810S
	12	XFD 3812S
	14	XFD 3814S



Diameter	L	Art. No.
Ø 3.95	8	XFD 4308S
	10	XFD 4310S
	12	XFD 4312S
	14	XFD 4314S



Diameter	L	Art. No.
Ø 4.50	8	XFD 4808S
	10	XFD 4810S
	12	XFD 4812S
	14	XFD 4814S



※ Note: Drill speed 1,000rpm, 30~45 N·cm with irrigation

Surgical Instruments

Unit: mm, Scale 1 : 1

Countersink



Diameter	L	Art. No.
Ø 3.6	29	XCS 36 29 SW
Ø 4.0	29	XCS 40 29 SW
Ø 4.5	29	XCS 45 29 SW
Ø 5.0	29	XCS 50 29 SW
Ø 6.0	27	XCS 60 29 SW
Ø 7.0	27	XCS 70 29 SW

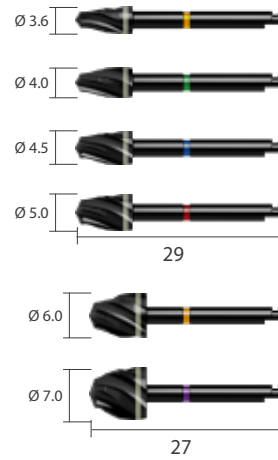

Round Bur

Diameter	L	Art. No.
Ø 2.0	33	XRБ 20 33
Ø 3.0		XRБ 30 33

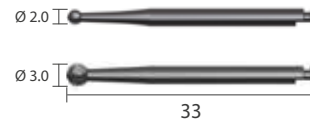

※ Note: Countersink Drill & Round Bur speed 1,000rpm, 30~45 N·cm with irrigation

Surgical Instruments

Unit: mm, Scale 1 : 1

Stopper I For first guide drill, second guide drill

Diameter	Drilling Depth	L	Art. No.
Ø 4.45	14	4.6	XLDST 14
	12	6.6	XLDST 12
	10	8.6	XLDST 10
	08	10.6	XLDST 08
	06	12.6	XLDST 06
	04	14.6	XLDST 04
	02	16.6	XLDST 02

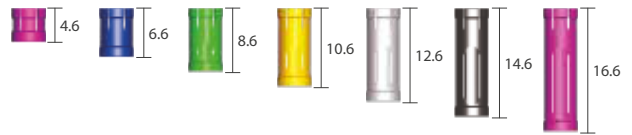

Stopper I For final drill 3435, 3835

Diameter	Drilling Depth	L	Art. No.
Ø 5.14	14	4.6	XFDST 14
	12	6.6	XFDST 12
	10	8.6	XFDST 10
	08	10.6	XFDST 08
	06	12.6	XFDST 06
	04	14.6	XFDST 04
	02	16.6	XFDST 02

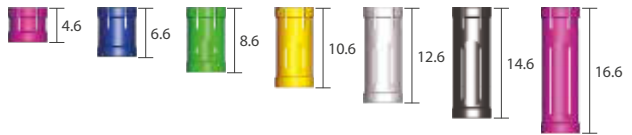

Stopper I For final drill 4335, 4835

Diameter	Drilling Depth	L	Art. No.
Ø 5.14	14	4.6	XFDST 14 L
	12	6.6	XFDST 12 L
	10	8.6	XFDST 10 L
	08	10.6	XFDST 08 L
	06	12.6	XFDST 06 L
	04	14.6	XFDST 04 L
	02	16.6	XFDST 02 L

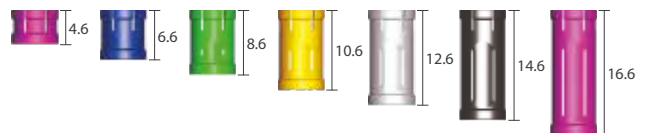

Surgical Instruments

Unit: mm, Scale 1 : 1

Fixture Adapter | Hex 2.5mm

Type	L	Art. No.
Hand-piece	27	XFA 27 H
	30	XFA 30 H
	32	XFA 32 H
Ratchet	24	XFA 24 W
	26	XFA 26 W
	29	XFA 29 W
	32	XFA 32 W

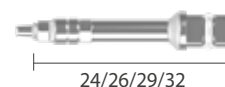
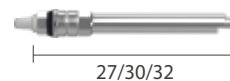

Fixtrue Adapter-clip | Hex 2.5mm

Type	L	Art. No.
Hand-piece	27	XCA 27 H
	30	XCA 30 H
	32	XCA 32 H
Ratchet	24	XCA 24 W
	26	XCA 26 W
	29	XCA 29 W
	32	XCA 32 W

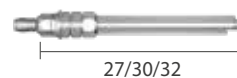

Parallel Pin | For first guide drill, second guide drill

Diameter	L	Art. No.
Ø 1.6	15.5	XPP 162212
	20	XPP 162220 T
	26	XPP 162226 T

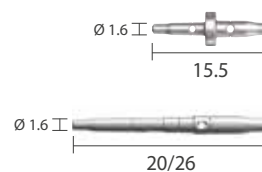

Path Pin

Diameter	L	Art. No.
Ø 1.6	18.6	XMFP A 2



Surgical Instruments

Unit: mm, Scale 1 : 1

Slot Driver

Type	L	Art. No.
Ratchet	17	SDA 17 R
	25	SDA 25 R

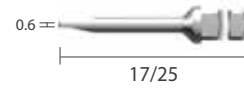

Hex Driver | Hex 1.28mm

Type	L	Art. No.
Hand-piece	17	XHDD 17 H
	25	XHDD 25 H
	30	XHDD 30 H
Ratchet	21	XHD 21 W
	25	XHD 25 W
	27	XHD 27 W
Manual	26	XHD 26 T
	30	XHD 30 T

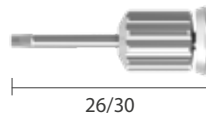
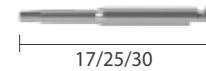

Angled Hex Driver

Type	L	Art. No.
Hand-piece	25	XAD 25 H
Ratchet	21	XAD 21 W
	25	XAD 25 W
	27	XAD 27 W
Manual	26	XAD 26 T
	30	XAD 30 T

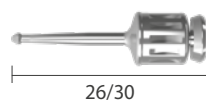
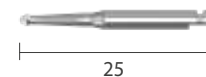

Drill Extension

Diameter	L	Art. No.
Ø 3.0	26	XDE

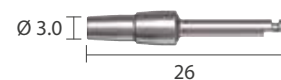

Adapter

Type	Diameter	Art. No.
Manual	Ø 12.0	XHDHT

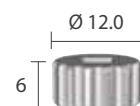

Surgical Instruments

Unit: mm, Scale 1 : 1

Screw Abutment Adapter

Type	L	Art. No.
Hand-piece	20	XMAA 1
Ratchet	21	XMA 21 W

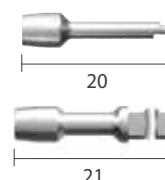

Mini Ball Abutment Adapter

Type	L	Art. No.
Ratchet	21	IPST 21 W



Ratchet

Scale 0.7 : 1

XRCA 1



Torque Wrench

Scale 0.7 : 1

XNTW



Depth Gauge

Scale 0.7 : 1

XDGL

※ Note: One side of Depth Gauge measures the osteotomy depth and the other side measures the gingival height from the top of the implant.



Tissue Punch

Diameter	L	Art. No.
Ø 4.0	27	XTS 40



Osteotome Kit

Unit: mm, Scale 1 : 1

Osteotome

Osteotome compresses the bone laterally, providing denser bony interface rather than removing valuable bone from the surgical site.



Osteotome Kit

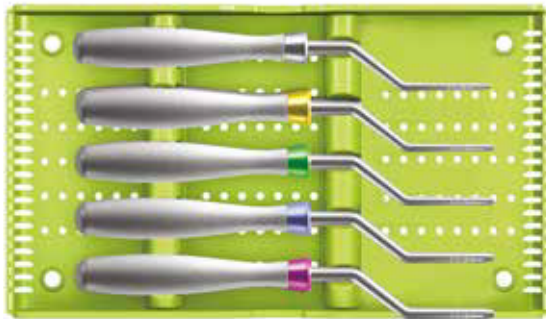

XOFK		XOFBK	
Type A (Convex)		Type B (Concave)	
XOF 20 A1		XOF 20 B1	
XOF 34 A1		XOF 34 B1	
XOF 38 A1		XOF 38 B1	
XOF 43 A1		XOF 43 B1	
XOF 48 A1		XOF 48 B1	

Osteotome | Final drill type | Scale 0.4 : 1

Type	Ø A	Ø B	Art. No.
Type A (Convex)	Ø 1.7	Ø 2.8	XOF 20 A1
	Ø 2.3	Ø 2.8	XOF 34 A1
	Ø 2.7	Ø 3.2	XOF 38 A1
	Ø 2.8	Ø 3.8	XOF 43 A1
	Ø 3.0	Ø 4.3	XOF 48 A1
Type B (Concave)	Ø 1.7	Ø 2.8	XOF 20 B1
	Ø 2.3	Ø 2.8	XOF 34 B1
	Ø 2.7	Ø 3.2	XOF 38 B1
	Ø 2.8	Ø 3.8	XOF 43 B1
	Ø 3.0	Ø 4.3	XOF 48 B1

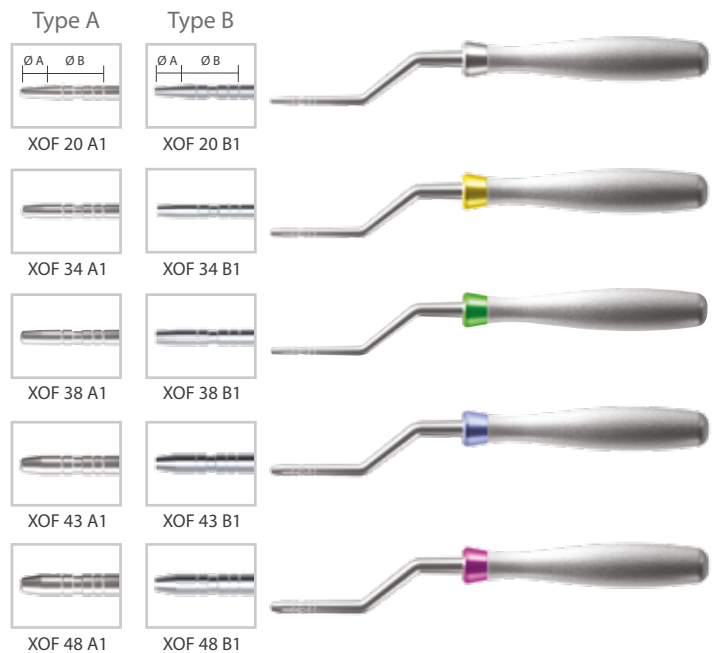

Trepine Kit

Unit: mm, Scale 1 : 1

Trepine Bur

- Excellent fine cutting
- Strong engagement when attaching the trephine to cortical bone
- Cut-outs facilitates ease of harvest retrieval
- 5 scale marks on the Trephine drill from 2mm to 10mm
- Easy harvesting

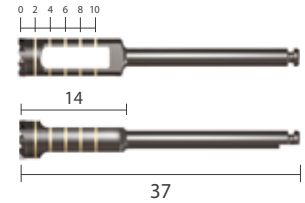

Trepine Kit

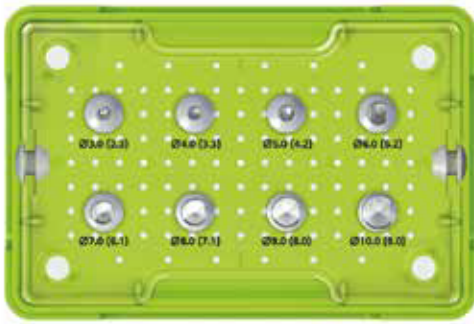

XIT

Kit Includes

XTP 24 03	XTP 34 04	XTP 44 05	XTP 54 06
XTP 64 07	XTP 74 08	XTP 84 09	XTP 94 10

Trepine Bur

Outer Diameter	Inner Diameter	Art. No.
Ø 3.0	Ø 2.4	XTP 24 03
Ø 4.0	Ø 3.4	XTP 34 04
Ø 5.0	Ø 4.4	XTP 44 05
Ø 6.0	Ø 5.4	XTP 54 06
Ø 7.0	Ø 6.4	XTP 64 07
Ø 8.0	Ø 7.4	XTP 74 08
Ø 9.0	Ø 8.4	XTP 84 09
Ø 10.0	Ø 9.4	XTP 94 10

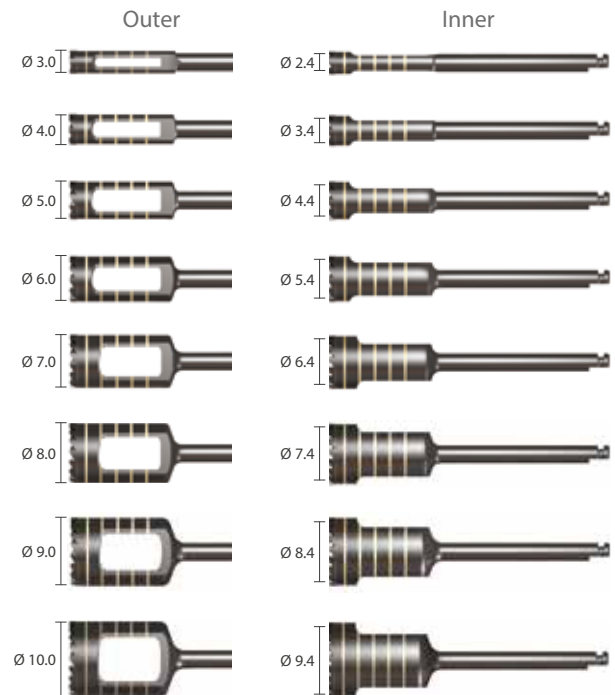

Instrument

Unit: mm, Scale 1 : 1.5

Screw Drill

Diameter	Art. No.
Ø1.2	GMD 1228

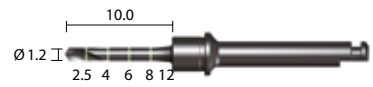

Membrane screw insertion tool

[Unit: mm, Scale 1 : 0.7]

Art. No.
GST26H
GST56
GST85
COD



GST **26H**



GST **56**



GST **85**



COD

Membrane Screws

Unit: mm, Scale 1 : 2

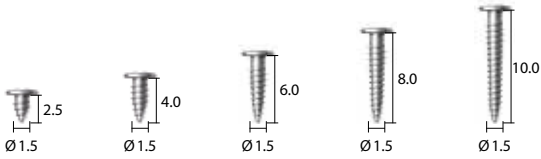

L	Art. No.
2.5	GSC 15 02
4.0	GSC 15 04
6.0	GSC 15 06
8.0	GSC 15 08
10.0	GSC 15 10

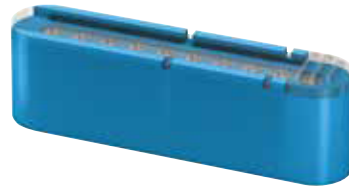

Screw case | Screw 10ea included

Membrane Pins

Unit: mm, Scale 1 : 2

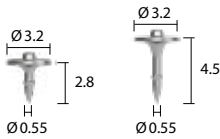

L	Art. No.
2.8	GMT3225
4.5	GMT3245

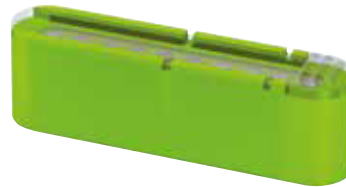

Pin case | Pin 10ea included



L	Art. No.
125.0	GMNT



Membrane Pin with insertion tool

Prosthetic Kit

Unit: mm, Scale 1 : 1

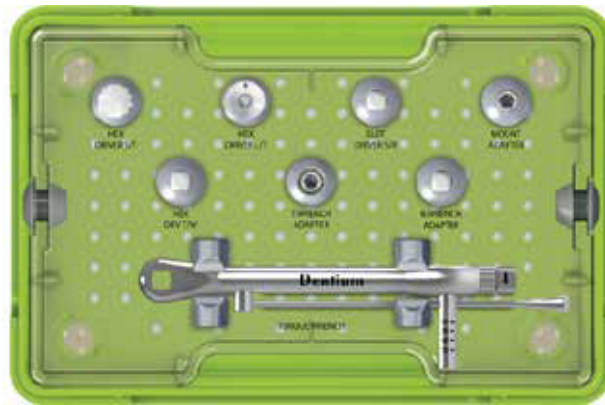

XIP

Hex Driver

Type	L	Art. No.
S/T	15	XHD 15
L/T	30	XHD 30 T
Torque Wrench	25	XHD 25 W



Adapter

Type	L	Art. No.
Screw Abutment	21	XMA 21 W
	20	XMAA 1
Mini Ball	21	IPST 21 W

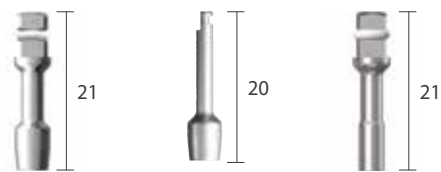

Slot Driver

SDA 25 R



Torque Wrench

XNTW

Scale 0.7 : 1



Planning Kit

Unit: mm, Scale 1 : 1

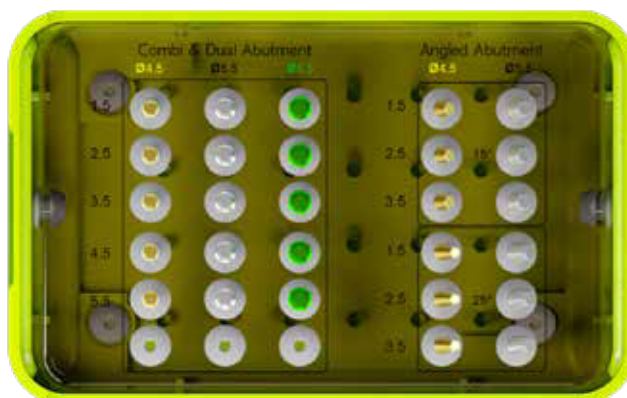

XPB

For Combi & Dual Abutment

Diameter	G/H	Art. No.
Ø 4.5	1.5	PCD 45 15
	2.5	PCD 45 25
	3.5	PCD 45 35
	4.5	PCD 45 45
	5.5	PCD 45 55
Ø 5.5	1.5	PCD 55 15
	2.5	PCD 55 25
	3.5	PCD 55 35
	4.5	PCD 55 45
	5.5	PCD 55 55
Ø 6.5	1.5	PCD 65 15
	2.5	PCD 65 25
	3.5	PCD 65 35
	4.5	PCD 65 45
	5.5	PCD 65 55

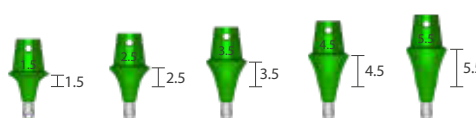
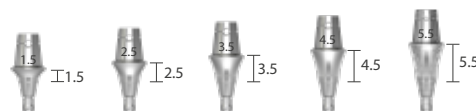
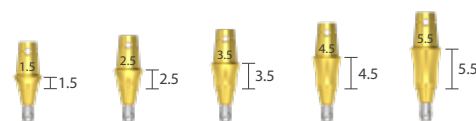

For Angled Abutment

Angled	Diameter	G/H	Art. No.
15°	Ø 4.5	1.5	PCA 15 45 15
		2.5	PCA 15 45 25
		3.5	PCA 15 45 35
	Ø 5.5	1.5	PCA 15 55 15
		2.5	PCA 15 55 25
		3.5	PCA 15 55 35
25°	Ø 4.5	1.5	PCA 25 45 15
		2.5	PCA 25 45 25
		3.5	PCA 25 45 35
	Ø 5.5	1.5	PCA 25 55 15
		2.5	PCA 25 55 25
		3.5	PCA 25 55 35



Prosthetic and Laboratory Instrument

Unit: mm, Scale 1 : 1

Hex Driver

Hex	L	Art. No.
1.28	13	XHD 13
	15	XHD 15
	21	XHD 21
	28	XHD 28

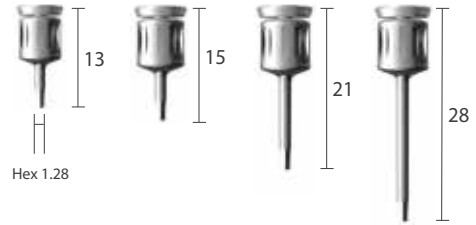

Reamer Guide

Application	Diameter	Art. No.
Combi / Dual Abutment	Ø 4.5	CRG 45 L
	Ø 5.5	CRG 55 L
	Ø 6.5	CRG 65 L

Application	Type	Art. No.
Screw Abutment	Bridge	SRG BL
	Single	SRG SL

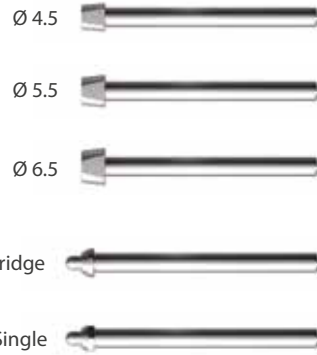

Reamer Handle

Scale 0.5 : 1

CRH



Hand Wrench

XHW



Reamer

Application	Art. No.
Combi / Dual Abutment	CRM
Screw Abutment	SRM



Help Kit

Unit: mm, Scale 1 : 1

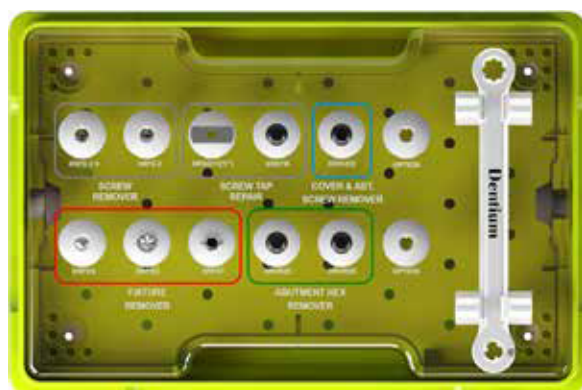

XSHK

Screw Remover

L	Art. No.
25	XRFS 2 S
33	XRFS 2

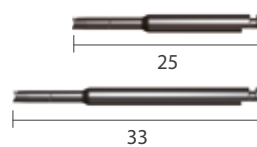

Screw Tap Repair

Type	Art. No.
Tap	XRSTR
11° Guide	XRSG 11



Fixture Remover

Type	Art. No.
Remover Screw	XRFS S
Screw Driver	XRFS D
Remover	XRFS T

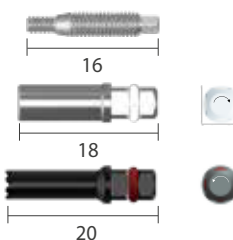

Abutment Hex Remover

L	Art. No.
20	XRHR 20
25	XRHR 25

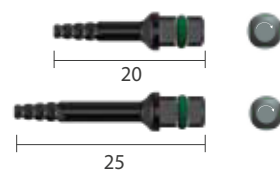

Cover & Abutment Screw Remover

L	Art. No.
25	XRRHDE

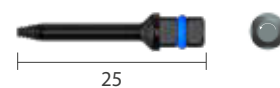

Wrench

Scale 1 : 0.7

XRFRW



Polymer Guide Kit

Unit: mm, Scale 1 : 1



PGSSK



PGSCSK

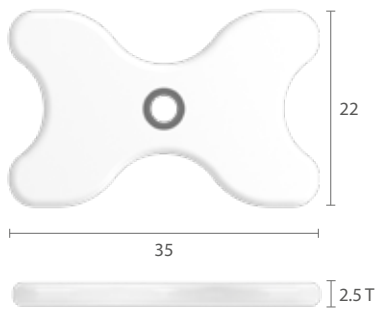

Single Standard (5ea)

T	Art No.
2.5	XSG 34 35 S

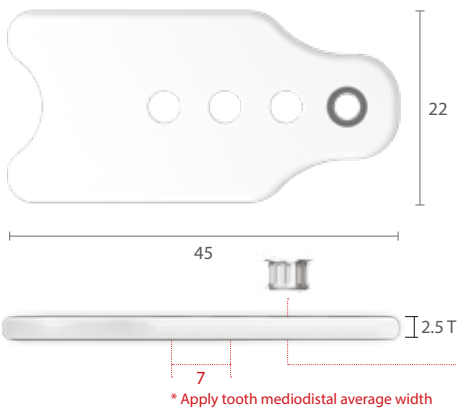

Cantilever Multi-Ready (5ea)

T	Art No.
2.5	XSG 34 45 C

※ 1 fixed Sleeve + 3 additional Sleeve Hole

Stone Drill



XGD 23 60 (1ea)

Guide Pin



XGP 34 23 S (5ea)

Additional Metal Sleeve
(for Cantilever Multi-Ready)



XPGS 34 25 A (5ea)

DASK

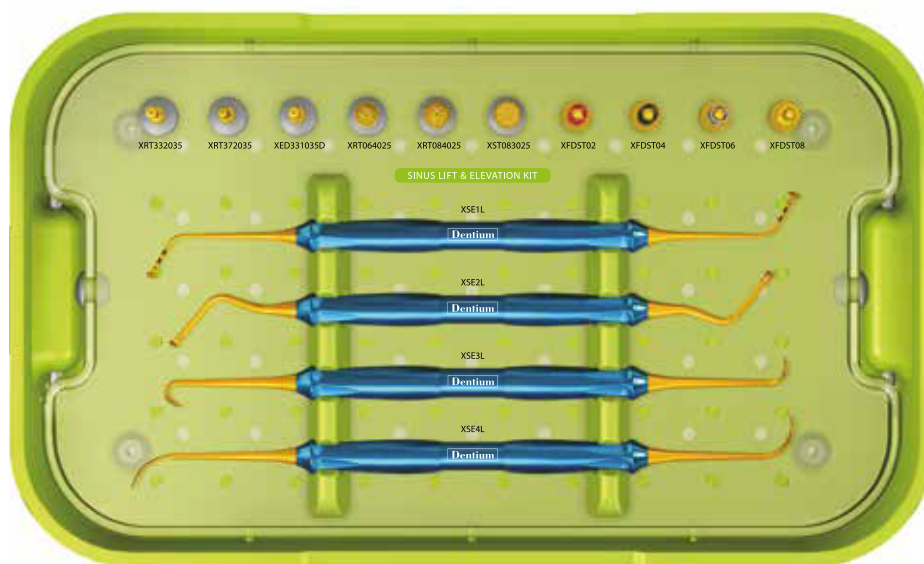

Dentium Advanced Sinus Kit

DASK

Kit Includes

DASK Drill

Stopper



Sinus Elevation Instrument



Sinus Bur Kit

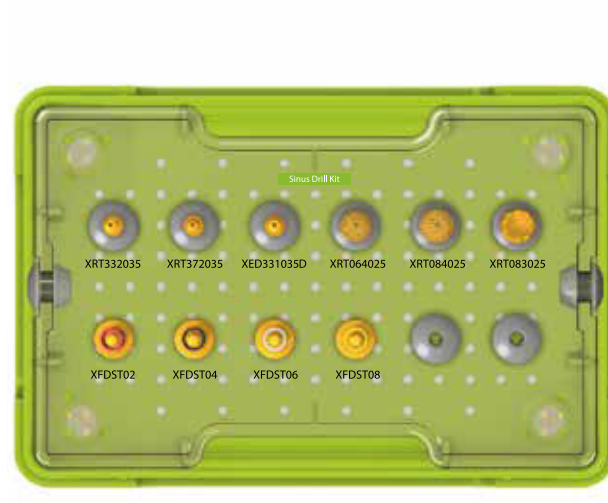

Sinus Bur Kit

SDK

Kit Includes

DASK Drill



Stopper



DASK / Sinus Bur Kit

Unit: mm, Scale 1 : 1

DASK Drill

Type	DASK Drill #	Art. No.
Crestal Approach	DASK Drill #1	XRT 33 20 35
	DASK Drill #2	XRT 37 20 35
	DASK Drill #3	XED 33 10 35 D
Lateral Approach	DASK Drill #4	XRT 06 40 25
	DASK Drill #5	XRT 08 40 25
	DASK Drill #6	XST 08 30 25

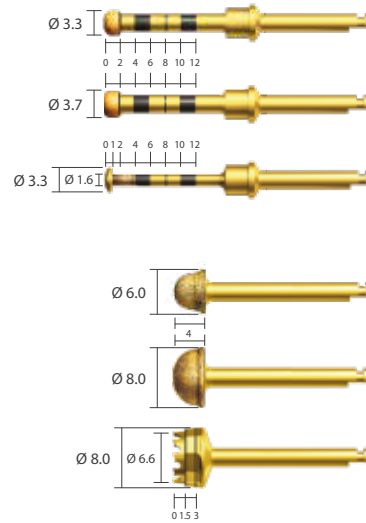

※ Note: Drill speed 800 to 1,200rpm, 30~45N-cm with irrigation

Stopper | For XRT332035, XRT372035, XED331035D

Diameter	Drilling Depth	L	Art. No.
Ø 5.14	08	10.6	XFDST 08
	06	12.6	XFDST 06
	04	14.6	XFDST 04
	02	16.6	XFDST 02

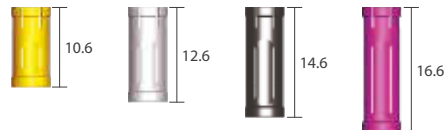

Sinus Elevation Instrument | Scale 0.45 : 1

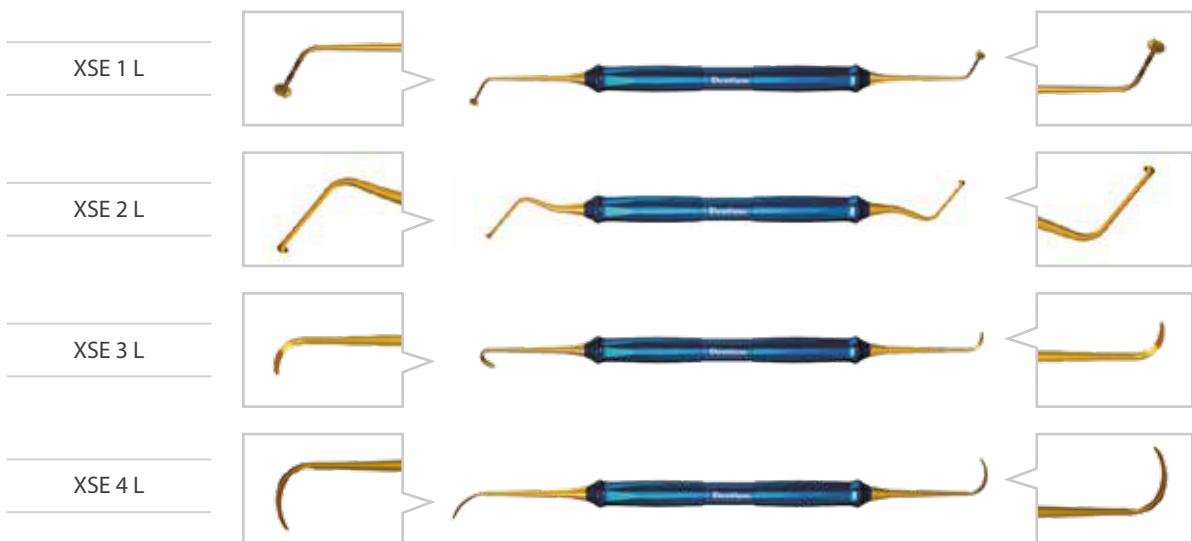

Ridge Spreader Kit

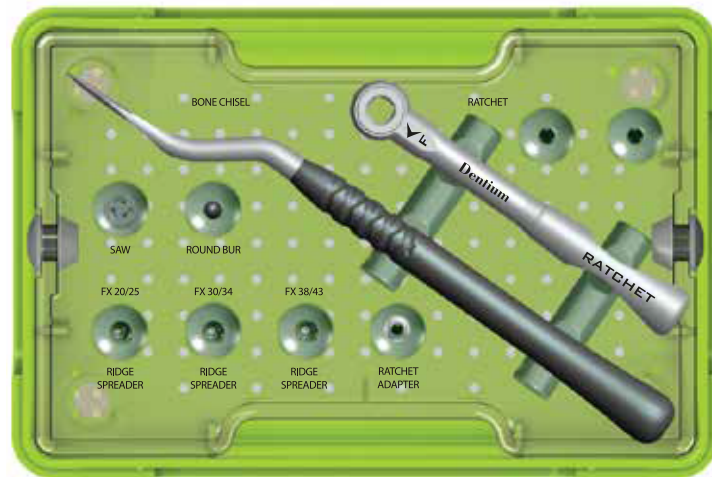

XRSK

Bone Chisel

XBC305013



Ratchet

XRCA1



[Unit: mm, Scale 0.6 : 1]

Ridge Spreader Drills

Diameter	L	Art No.
Ø1.4 / Ø2.4	35	RS142435
Ø2.0 / Ø3.2	35	RS203235
Ø2.6 / Ø3.6	35	RS263635



Round Bur

Diameter	L	Art No.
Ø4.0	35	XR4035



Ratchet Adapter

XRA3917



Mini Saw

Diameter	L	Art No.
Ø8.0	25	XDS8025

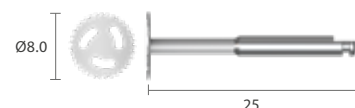

[Unit: mm, Scale 1 : 1]

Sinus Kit

Unit: mm, Scale 1 : 1

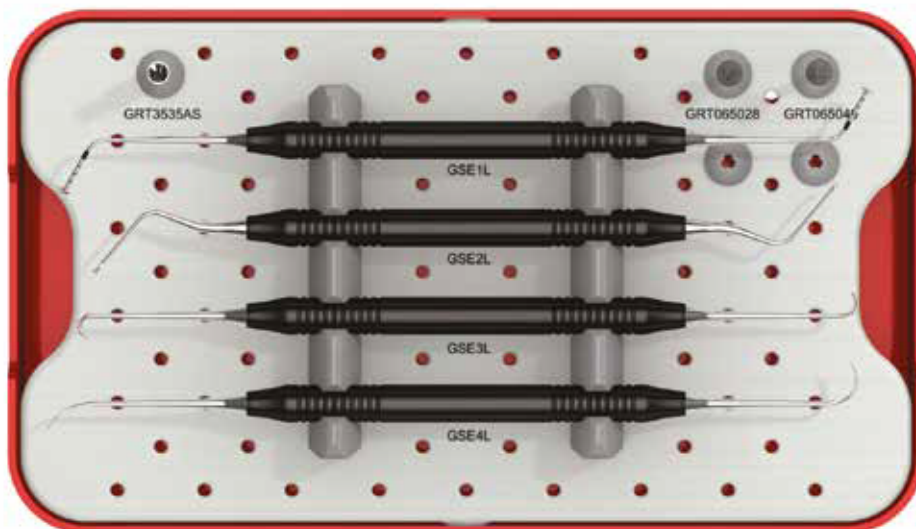

GSEK

Crestal Drill

Diameter	L	Art No.
Ø3.5	35	GRT 35 35 AS

※ Note: Drill speed 20~60 rpm, 30~45N-cm with irrigation

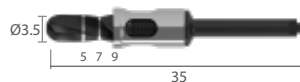

Lateral Drill

Diameter	L	Art No.
Ø6.0	28	GRT 06 50 28
Ø6.0	40	GRT 06 50 40

※ Note: Drill speed 800 to 1,200rpm, 30~45N-cm with irrigation

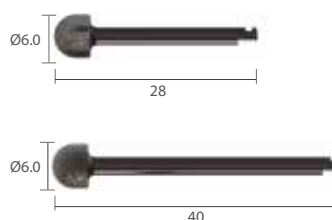

Sinus Curette Scale 1 : 2 / mm



Ridge Expander Kit

Unit: mm, Scale 1 : 1

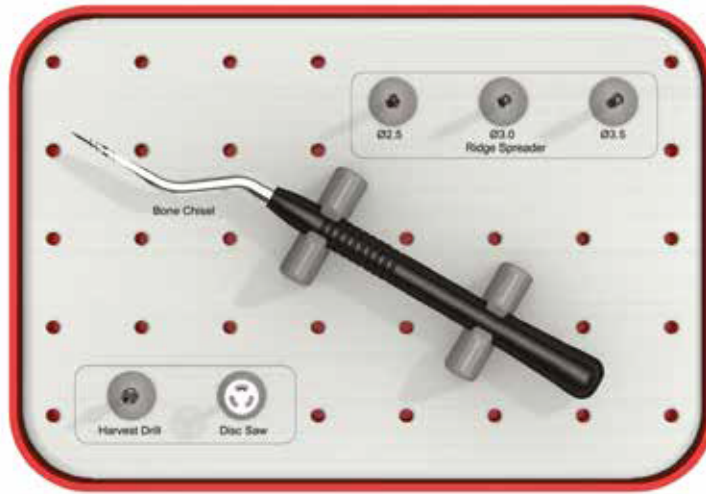

GREK

Ridge Spreader

Diameter	L	Art No.
Ø1.3 / Ø2.5	32	GRS 13 25
Ø1.8 / Ø3.0	32	GRS 18 30
Ø2.3 / Ø3.5	32	GRS 23 35

※ Note: condensing drill 20~60 rpm,
30~45N·cm with irrigation

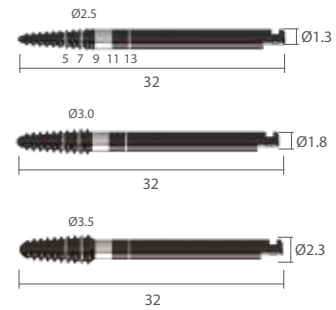

Harvest Drill

Diameter	L	Art No.
Ø3.0	29	GHD 30 29

※ Note: Harvest Drill speed 20~60rpm,
30~45 N·cm without irrigation



Disc Saw

Diameter	L	Art No.
Ø8.0	25	GDS 80 25

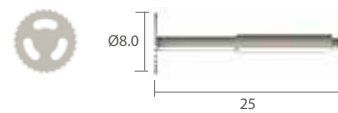

Bone Chisel

GBC 18 45 13



Implant Guide Kit

Unit: mm, Scale 1 : 1

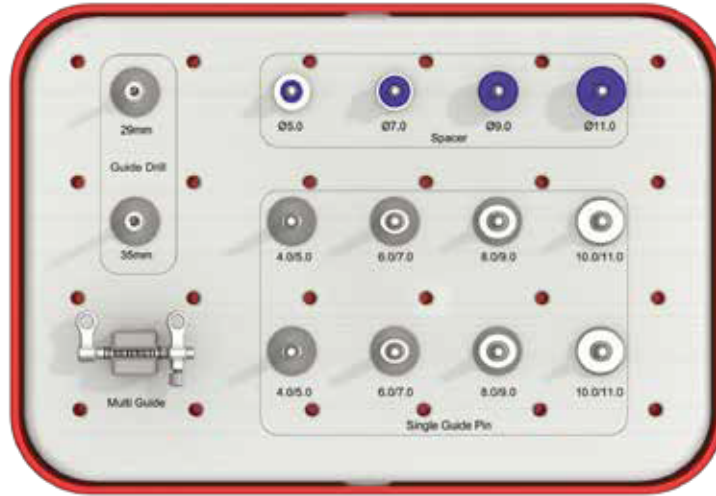

GIGK

Guide Drill

Diameter		Art No.
Ø2.6	29	GGD 26 29
	35	GGD 26 35

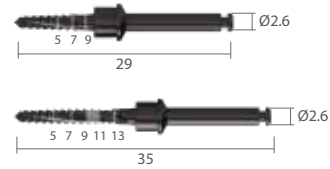

Spacer

Width	Art No.
5.0	GSP 05
7.0	GSP 07
9.0	GSP 09
11.0	GSP 11



Single Guide Pin

Width	Art No.
4.0 / 5.0	GGP 04 05
6.0 / 7.0	GGP 06 07
8.0 / 9.0	GGP 08 09
10.0 / 11.0	GGP 10 11

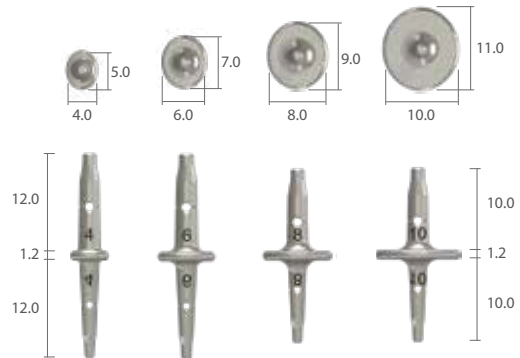

Multi Guide

GMG2



Digital Guide | Simple Kit for Positioning, Anchor

Unit: mm, Scale 1 : 1

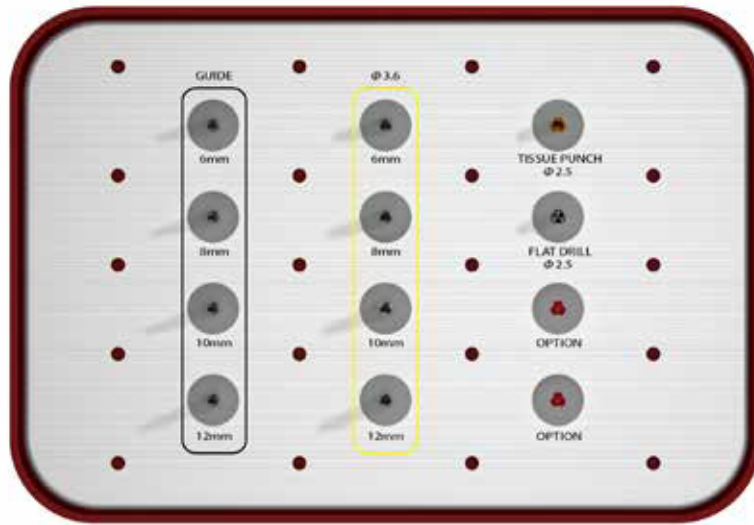

XGSSK

SuperLine FSX3608 Guide Drilling Sequence

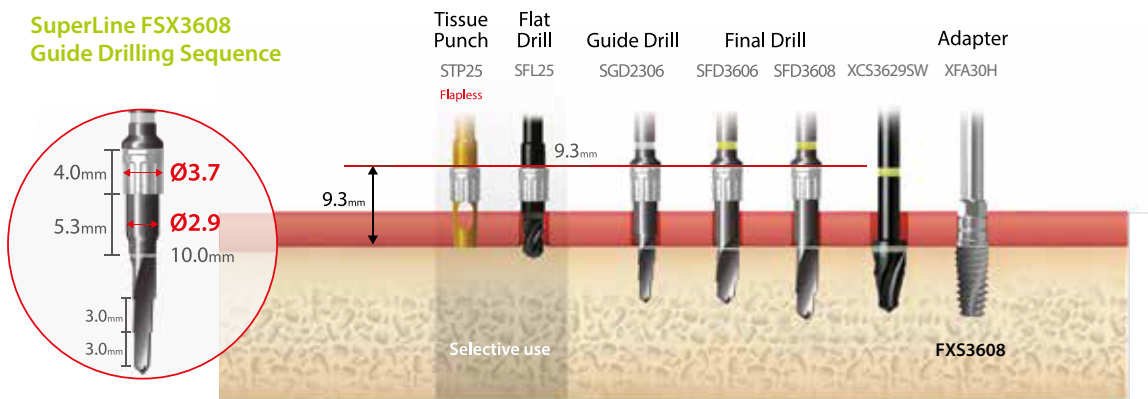

Guide Drill



SGD2306 SGD2308 SGD2310 SGD2312

FX 36 Final Drill

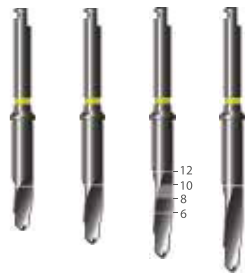

SFD3606 SFD3608 SFD3610 SFD3612

Tissue Punch



STP25

Flat Drill



SFL25

Ti-Sleeve



SMS30

Ti-Open Sleeve



SOS30

Digital Guide | Full Kit for FX 36/40/45

Unit: mm, Scale 1 : 1

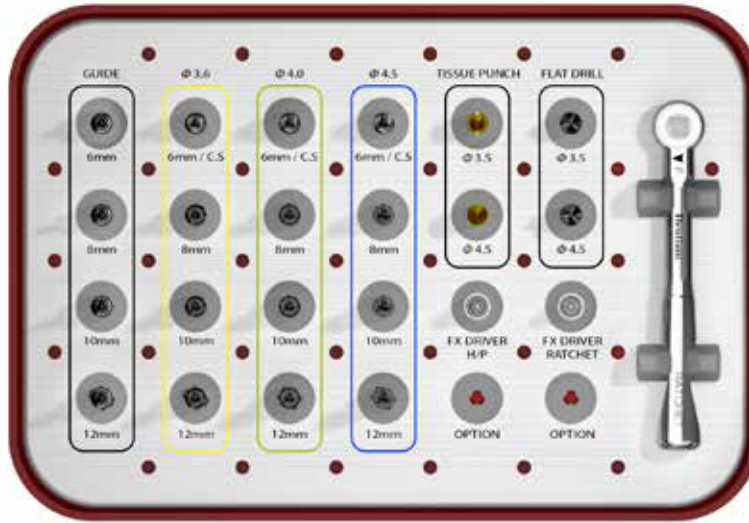

XGSFK

SuperLine FSX4508 Guide Drilling Sequence

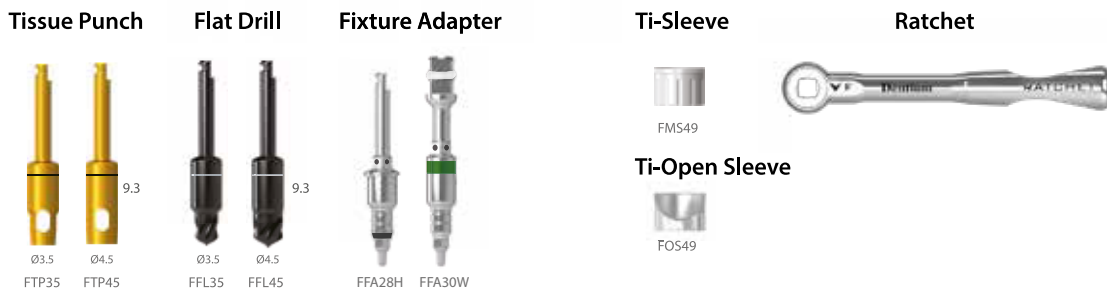
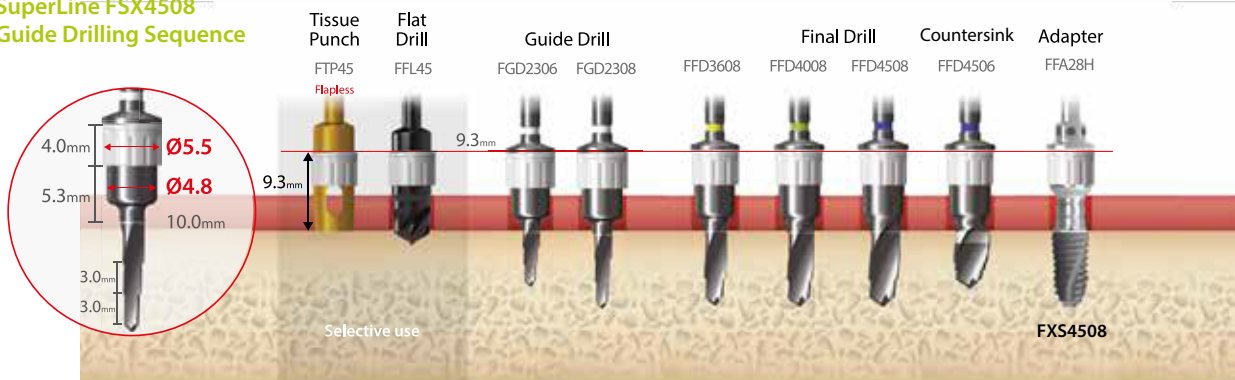

Digital Guide | 5.0 Kit for FX 36/40/45/50

Unit: mm, Scale 1 : 1

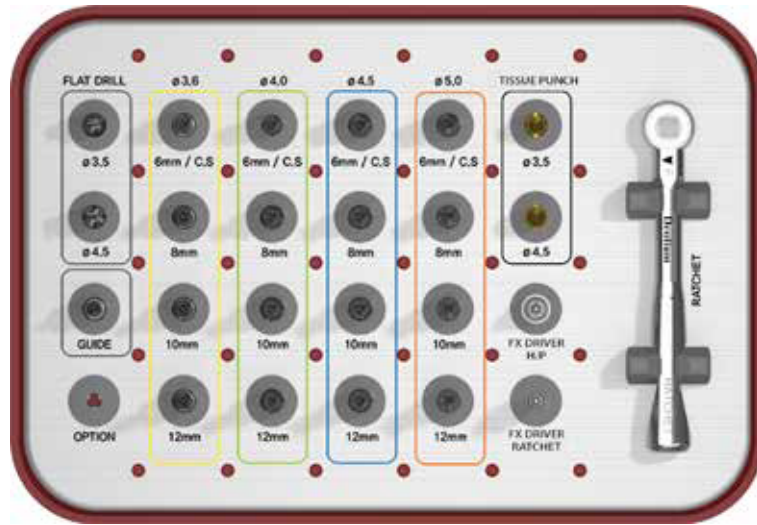

XGSFKW

SuperLine FXS5008 Guide Drilling Sequence

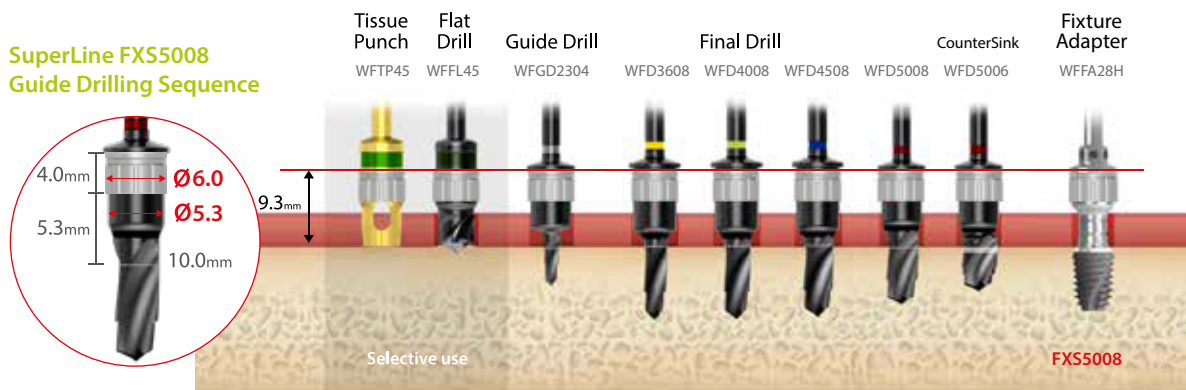

Guide Drill



WFGD2304

FX36 Final Drill



Countersink

WFFD3606 WFFD3608 WFFD3610 WFFD3612

FX40 Final Drill



Countersink

WFFD4006 WFFD4008 WFFD4010 WFFD4012

FX45 Final Drill



Countersink

WFFD4506 WFFD4508 WFFD4510 WFFD4512

FX50 Final Drill



Countersink

WFFD5006 WFFD5008 WFFD5010 WFFD5012

Tissue Punch

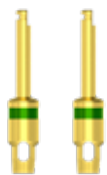

WFTP35 WFTP45

Flat Drill



WFFL35 WFFL45

Fixture Adapter



WFFA28H WFFA30W

Ti-Sleeve



FM554

Ti-Open Sleeve



FO554

Ratchet



XRCA1

New SuperLine II

Product Catalog

Dentium

Specifications are subject to change without any notice.
Some products listed in this catalog are not available in the market due to pending approval.

HEAD OFFICE

10F, 21, Teheran-ro 87-gil, Gangnam-gu, Seoul, Korea Tel +82-2-555-3750 Fax +82-2-501-9560

HOME PAGE

www.dentium.co.kr

NS2PC-202101[Rev.0]